

JVC

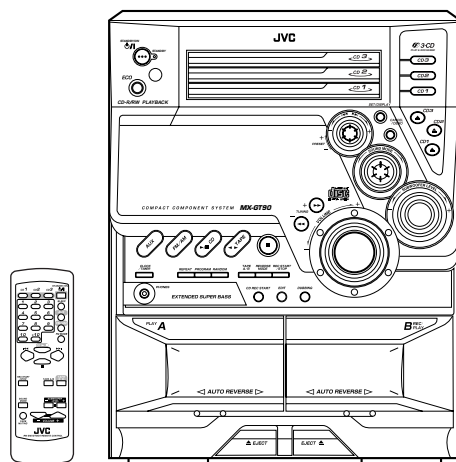

COMPACT COMPONENT SYSTEM

CA-MXGT90/CA-MXGT80 CA-MXG70



CA-MXGT90

COMPACT
disc
DIGITAL AUDIO

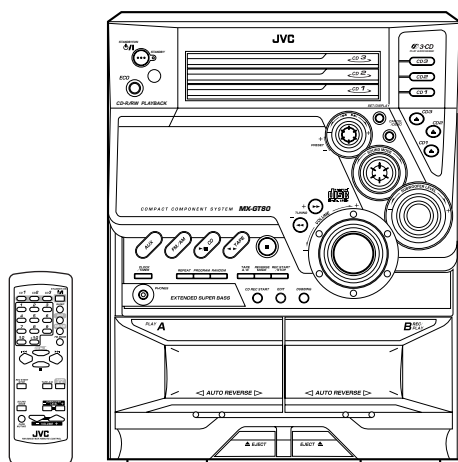

CA-MXGT80

COMPACT
disc
DIGITAL AUDIO

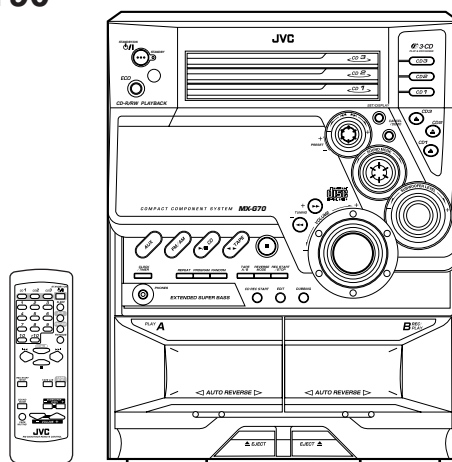

CA-MXG70

COMPACT
disc
DIGITAL AUDIO

INSTRUCTIONS

For Customer Use:

Enter below the Model No. and Serial No. which are located either on the rear, bottom or side of the cabinet. Retain this information for future reference.

Model No. _____

Serial No. _____

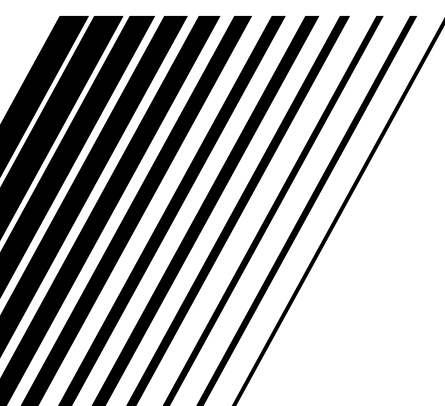

Warnings, Cautions and Others

Caution — STANDBY/ON button!

Disconnect the mains plug to shut the power off completely.
The STANDBY/ON  button in any position does not disconnect the mains line. The power can be remote controlled.

CAUTION

To reduce the risk of electrical shocks, fire, etc.:

1. Do not remove screws, covers or cabinet.
2. Do not expose this appliance to rain or moisture.

CAUTION

- Do not block the ventilation openings or holes.
(If the ventilation openings or holes are blocked by a newspaper or cloth, etc., the heat may not be able to get out.)
- Do not place any naked flame sources, such as lighted candles, on the apparatus.
- When discarding batteries, environmental problems must be considered and local rules or laws governing the disposal of these batteries must be followed strictly.
- Do not use this apparatus in a bathroom or places with water. Also do not place any containers filled with water or liquids (such as cosmetics or medicines, flower vases, potted plants, cups, etc.) on top of this apparatus.

IMPORTANT FOR LASER PRODUCTS

REPRODUCTION OF LABELS

- ① CLASSIFICATION LABEL, PLACED ON REAR ENCLOSURE

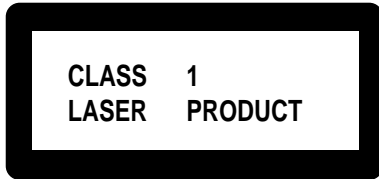

1. CLASS 1 LASER PRODUCT
2. **DANGER:** Invisible laser radiation when open and interlock failed or defeated. Avoid direct exposure to beam.
3. **CAUTION:** Do not open the top cover. There are no user serviceable parts inside the Unit; leave all servicing to qualified service personnel.

- ② WARNING LABEL, PLACED INSIDE THE UNIT

DANGER: Invisible laser radiation when open and interlock failed or defeated. AVOID DIRECT EXPOSURE TO BEAM. (e)	WARNING: Osynlig laserstrålning när denna del är öppnad och spärren är urkopplad. Beträkta ej strålen. (s)	ADVARSEL: Usynlig laserstrålning ved åbning, når sikkerhedsafbrydere er ude af funktion. Undgå udsættelse for stråling (d)	VARO: Avattaessa ja suo- jaukutus ohitettaessa olet alttiina näkymättömälle lasersäteilylle. Älä katso säteeseen. (f)
---	---	---	--

Caution: Proper Ventilation

To avoid risk of electric shock and fire, and to prevent damage, locate the apparatus as follows:

- 1 Front: No obstructions and open spacing.
- 2 Sides/ Top/ Back: No obstructions should be placed in the areas shown by the dimensions below.
- 3 Bottom: Place on the level surface. Maintain an adequate air path for ventilation by placing on a stand with a height of 10 cm or more.

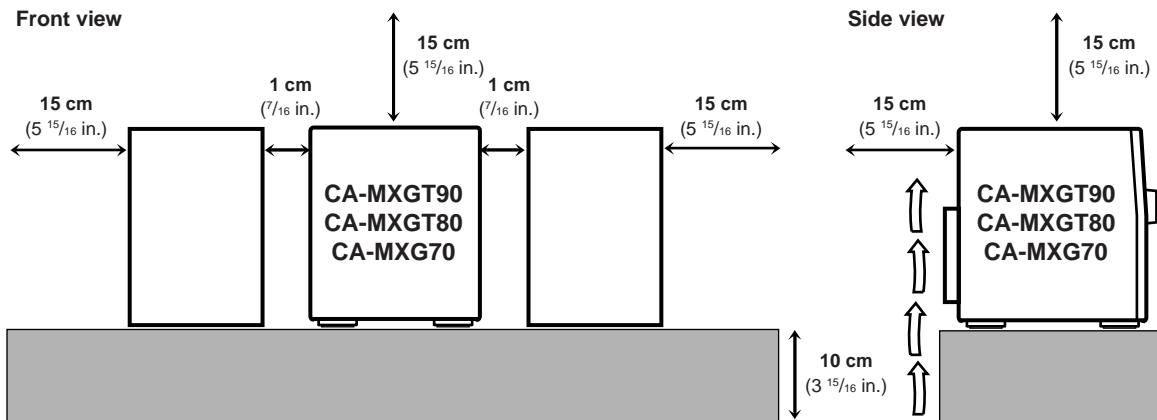

Introduction

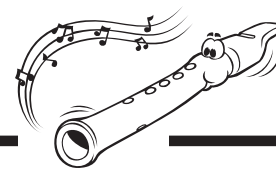

We would like to thank you for purchasing one of our JVC products. Before operating this unit, read this manual carefully and thoroughly to obtain the best possible performance from your unit, and retain this manual for future reference.

About This Manual

This manual is organized as follows:

- The manual mainly explains operations using the buttons and controls on the unit. You can also use the buttons on the remote control if they have the same or similar names (or marks) as those on the unit. If operation using the remote control is different from that using the unit, it is then explained.
- Basic and common information that is the same for many functions is grouped in one place, and is not repeated in each procedure. For instance, we do not repeat the information about turning on/off the unit, setting the volume, changing the sound effects, and others, which are explained in the section “Common Operations” on pages 9 to 11.
- The following marks are used in this manual:



Gives you warnings and cautions to prevent from damage or risk of fire/electric shock. Also gives you information which is not good for obtaining the best possible performance from the unit.



Gives you information and hints you had better know.

Precautions

Installation

- Install in a place which is level, dry and neither too hot nor too cold — between 5°C (41°F) and 35°C (95°F).
- Install the unit in a location with adequate ventilation to prevent internal heat buildup in the unit.
- Leave sufficient distance between the unit and the TV.
- Keep the speakers away from the TV to avoid interference with TV.



DO NOT install the unit in a location near heat sources, or in a place subject to direct sunlight, excessive dust or vibration.

Power sources

- When unplugging from the wall outlet, always pull the plug, not the AC power cord.



DO NOT handle the AC power cord with wet hands.

Moisture condensation

Moisture may condense on the lens inside the unit in the following cases:

- After starting heating in the room
 - In a damp room
 - If the unit is brought directly from a cold to a warm place
- Should this occur, the unit may malfunction. In this case, leave the unit turned on for a few hours until the moisture evaporates, unplug the AC power cord, and then plug it in again.

Others

- Should any metallic object or liquid fall into the unit, unplug the unit and consult your dealer before operating any further.
- If you are not going to operate the unit for an extended period of time, unplug the AC power cord from the wall outlet.



DO NOT disassemble the unit since there are no user serviceable parts inside.

If anything goes wrong, unplug the AC power cord and consult your dealer.

Contents

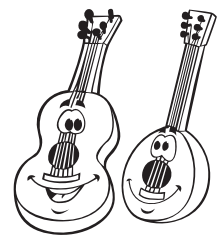

Location of the Buttons and Controls	3	Playing Back CDs (CD/CD-R/CD-RW)	13
Front Panel	3	Loading CDs	13
Remote Control	5	Playing Back the Entire Discs	
Getting Started	6	— Continuous Play	14
Supplied Accessories	6	Basic CD Operations	14
Putting the Batteries into the Remote Control	6	Programming the Playing Order of the Tracks	
Connecting Antennas	6	— Program Play	15
Connecting Speakers	7	Playing at Random — Random Play	16
Connecting Other Equipment	8	Repeating Tracks or CDs — Repeat Play	16
Canceling the Display Demonstration	8	Prohibiting Disc Ejection — Tray Lock	16
Common Operations	9	Playing Back Tapes	17
Turning On or Off the Power	9	Playing Back a Tape	17
Saving the Power Consumption While on Standby		Locating the Beginning of a Song — Music Scan ...	17
— Ecology Mode	9	Recording	18
Setting the Clock	9	Recording a Tape on Deck B	18
Selecting the Sources	9	Dubbing Tapes	19
Adjusting the Volume	10	CD Direct Recording	19
Reinforcing the Bass Sound	10	Auto Edit Recording	20
Selecting the Sound Modes	10	Using the Timers	21
Creating Your Own Sound Mode		Using Daily Timer	21
— Manual Mode	11	Using Recording Timer	23
Listening to FM and AM Broadcasts	12	Using Sleep Timer	24
Tuning in a Station	12	Timer Priority	24
Presetting Stations	12	Maintenance	25
Tuning in a Preset Station	12	Troubleshooting	26
		Specifications	27

Location of the Buttons and Controls

Become familiar with the buttons and controls on your unit.

Front Panel

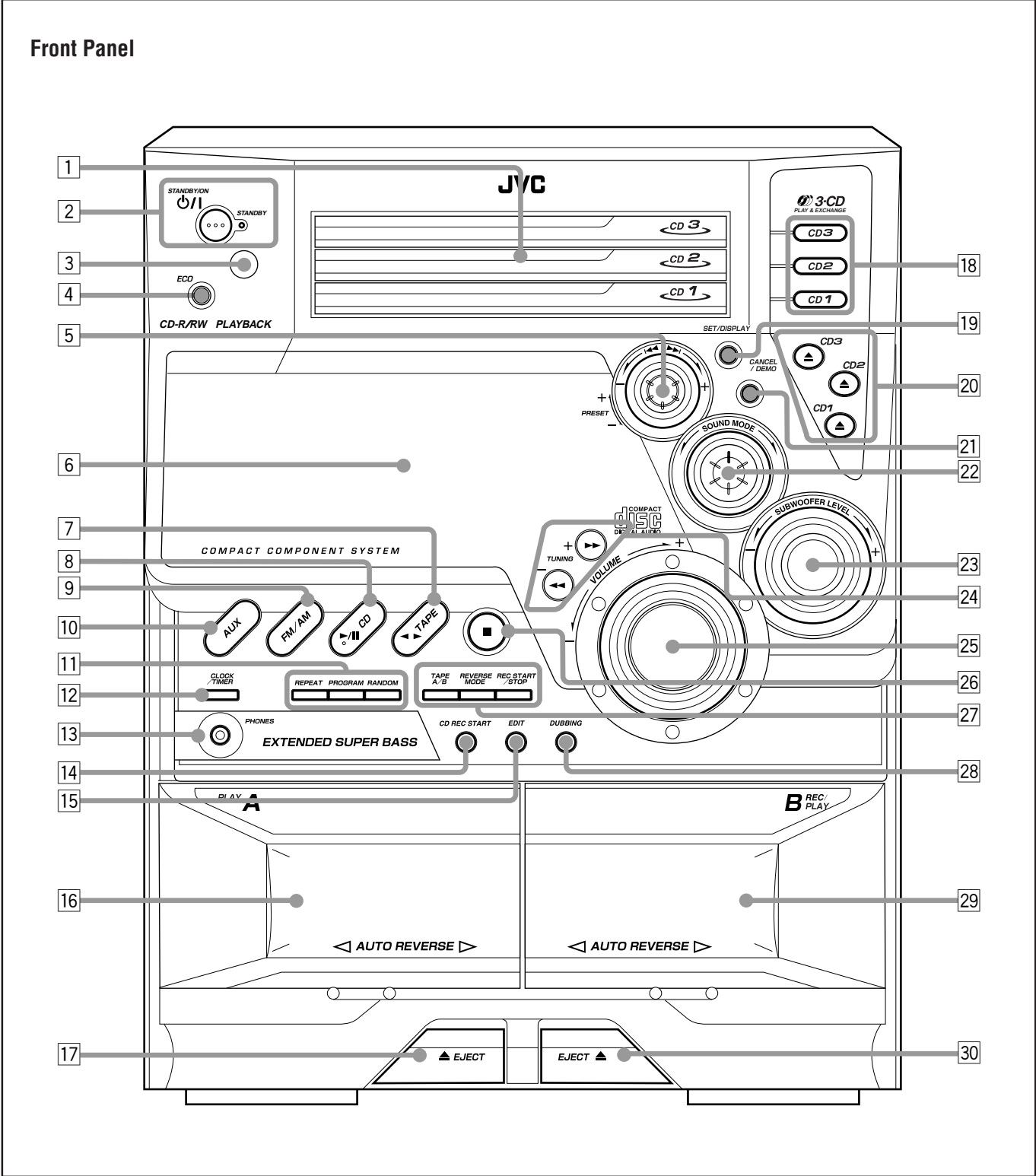

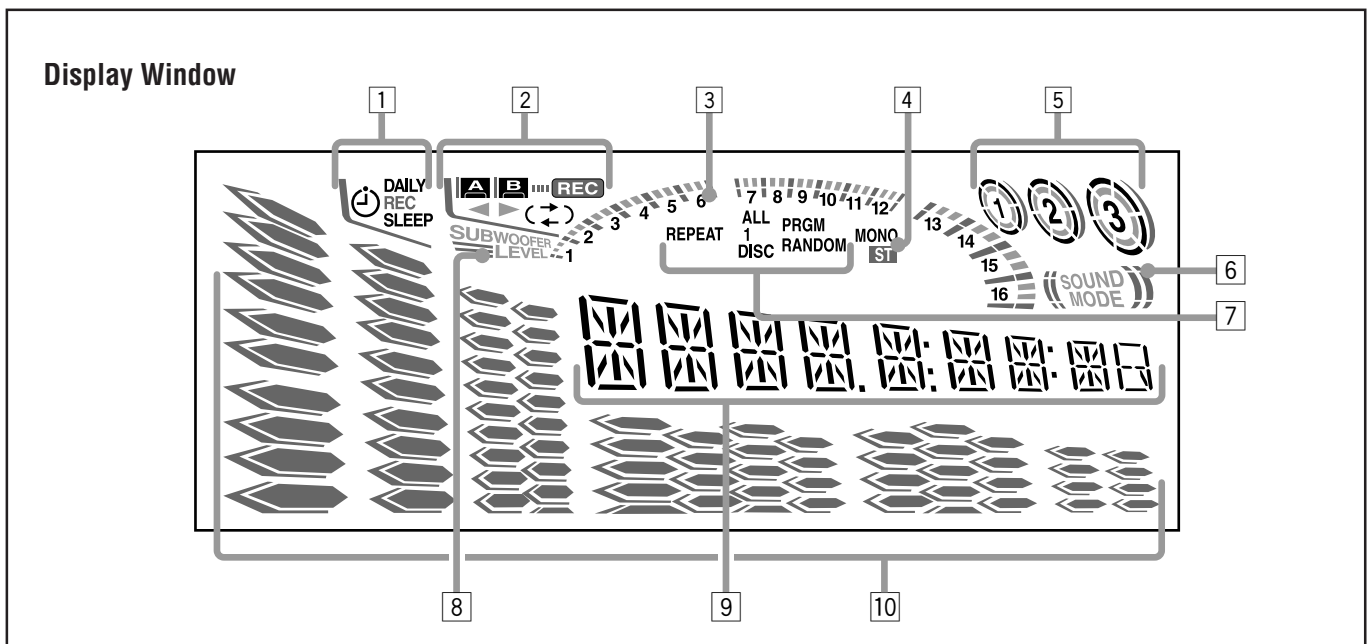

See pages in the parentheses for details.

Front Panel

- 1 Disc trays
- 2 STANDBY/ON button and STANDBY lamp (9, 22, 23)
- 3 Remote sensor
- 4 ECO button (9)
- 5 PRESET + / - control (12)
◀◀ / ▶▶ (reverse search/forward search) control (9, 11, 14 – 16, 20 – 23)
- 6 Display window
- 7 TAPE ◀▶ button and lamp (9, 17 – 19)
Pressing this button also turns on the unit.
- 8 CD ▶/|| (play/pause) button and lamp (9, 14 – 16, 20)
Pressing this button also turns on the unit.
- 9 FM/AM button and lamp (9, 12)
Pressing this button also turns on the unit.
- 10 AUX button and lamp (9)
Pressing this button also turns on the unit.
- 11 CD play mode buttons
 - REPEAT button (16)
 - PROGRAM button (15)
 - RANDOM button (16)
- 12 CLOCK/TIMER button (9, 21 – 24)
- 13 PHONES jack (10)
- 14 CD REC START button (19, 20)
- 15 EDIT button (20)
- 16 Deck A cassette holder (17)
- 17 ▲ EJECT button for deck A (17)
- 18 Disc number buttons and lamps (CD1, CD2, and CD3) (14, 15, 19, 20)
Pressing one of these buttons also turns on the unit.
- 19 SET/DISPLAY button (9, 11, 12, 15, 20 – 24)
- 20 ▲ (Disc tray open/close) (CD1, CD2, and CD3) buttons (13, 14, 16)
Pressing one of these buttons also turns on the unit.
- 21 CANCEL/DEMO button (8, 9, 15, 20 – 24)

- 22 SOUND MODE control (10)
- 23 SUBWOOFER LEVEL + / - control (10)
- 24 TUNING + / - buttons (12)
◀◀ / ▶▶ (fast left/fast right) buttons (11, 14, 17)
- 25 VOLUME + / - control (10)
- 26 ■ (stop) button (14 – 20, 23)
- 27 Tape operation buttons
 - TAPE A/B button (17)
 - REVERSE MODE button (17, 19, 20)
 - REC START/STOP button (18 – 20, 23)
- 28 DUBBING button (19)
- 29 Deck B cassette holder (17 – 20, 23)
- 30 EJECT ▲ button for deck B (17, 18)

Display Window

- 1 Timer indicators
 - ☉ (Timer), DAILY (Daily Timer), REC (Recording Timer), and SLEEP (Sleep Timer) indicators
- 2 Tape operation indicators
 - A/B (operating deck), REC (recording), ◀▶ (tape direction), and (↺) (reverse mode) indicators
- 3 CD track number (1 – 16) indicators
- 4 Tuner operation indicators
 - MONO and ST (stereo) indicators
- 5 Disc indicators
- 6 SOUND MODE indicator
- 7 CD play mode indicators
 - REPEAT (ALL/1/DISC), PRGM (program), and RANDOM indicators
- 8 SUBWOOFER LEVEL indicator
- 9 Main display
 - Shows the source name, frequency, etc.
- 10 Audio level indicator



Remote Control

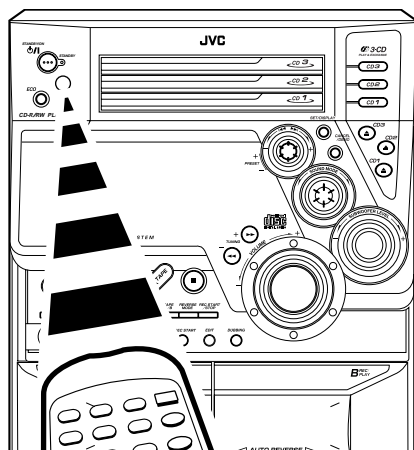
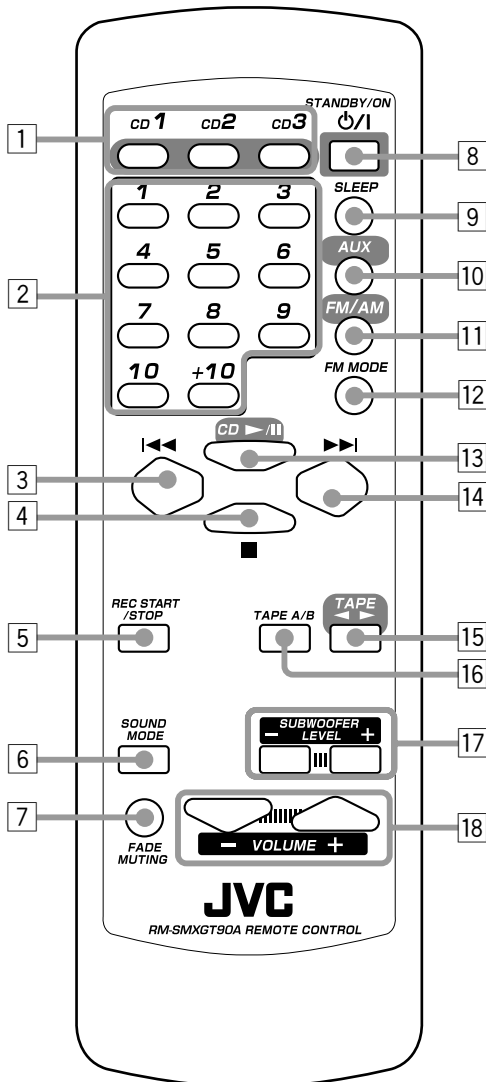

When using the remote control, point it at the remote sensor on the front panel.

Remote Control

- 1 Disc number buttons (CD1, CD2, and CD3) (14, 15)
Pressing one of these buttons also turns on the unit.
- 2 Number buttons (12, 14, 15)
- 3 ◀◀ (reverse search) button (12, 14, 15, 17)
- 4 ■ (stop) button (14 – 20, 23)
- 5 REC START/STOP button (18 – 20, 23)
- 6 SOUND MODE button (10)
- 7 FADE MUTING button (10)
- 8 STANDBY/ON ⏻/⏻ button (9)
- 9 SLEEP button (24)
- 10 AUX button (9)
Pressing this button also turns on the unit.
- 11 FM/AM button (9, 12)
Pressing this button also turns on the unit.
- 12 FM MODE button (12)
- 13 CD ▶/⏻ button (9, 14 – 16)
Pressing this button also turns on the unit.
- 14 ▶▶ (forward search) button (12, 14 – 17)
- 15 TAPE ◀▶ button (9, 17, 18)
Pressing this button also turns on the unit.
- 16 TAPE A/B button (17)
- 17 SUBWOOFER LEVEL + / – buttons (10)
- 18 VOLUME + / – buttons (10)

Supplied Accessories

Make sure that you have all the following items. The number in the parentheses indicates the quantity of the pieces supplied.

- AM loop antenna (1)
- FM antenna (1)
- Remote control (1)
- Batteries (2)

If anything is missing, consult your dealer immediately.

Putting the Batteries into the Remote Control

Insert the batteries — R6(SUM-3)/AA(15F) — into the remote control, by matching the polarity (+ and -) on the batteries with the + and - markings on the battery compartment.

When the remote control can no longer operate the unit, replace both batteries at the same time.

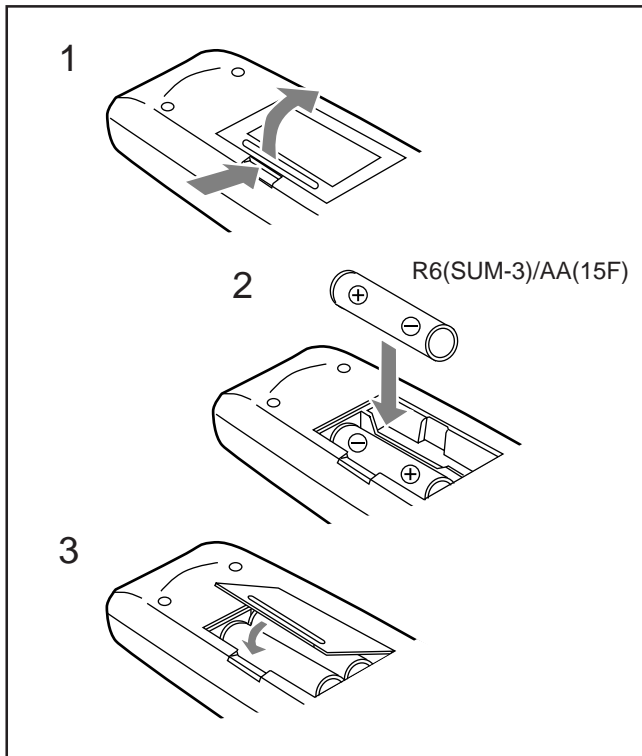

- DO NOT use an old battery together with a new one.
- DO NOT use different types of batteries together.
- DO NOT expose batteries to heat or flame.
- DO NOT leave the batteries in the battery compartment when you are not going to use the remote control for an extended period of time. Otherwise, it will be damaged from battery leakage.

Connecting Antennas

FM antenna

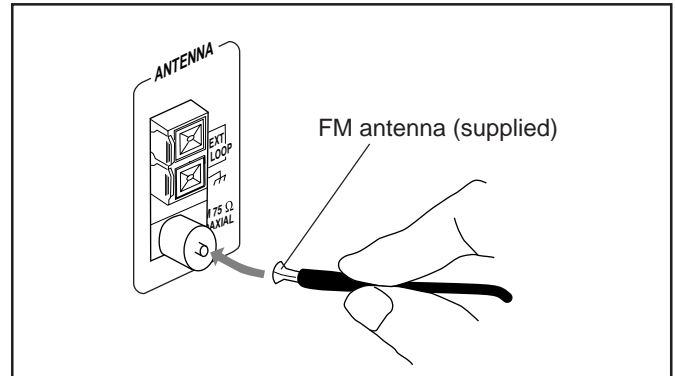

- 1 Attach the FM antenna to the FM 75 Ω COAXIAL terminal.
- 2 Extend the FM antenna.
- 3 Fasten it up in the position which gives you the best reception, then fix it on the wall, etc.



About the supplied FM antenna

The FM antenna supplied with this unit can be used as temporary measure. If reception is poor, you can connect an outdoor FM antenna.

To connect an outdoor FM antenna

Before connecting it, disconnect the supplied FM antenna.

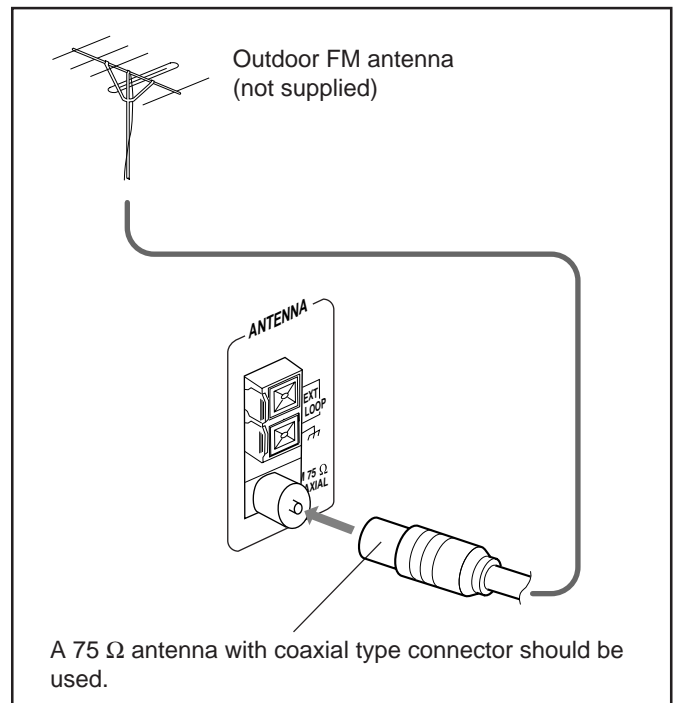

A 75 Ω antenna with coaxial type connector should be used.

AM antenna

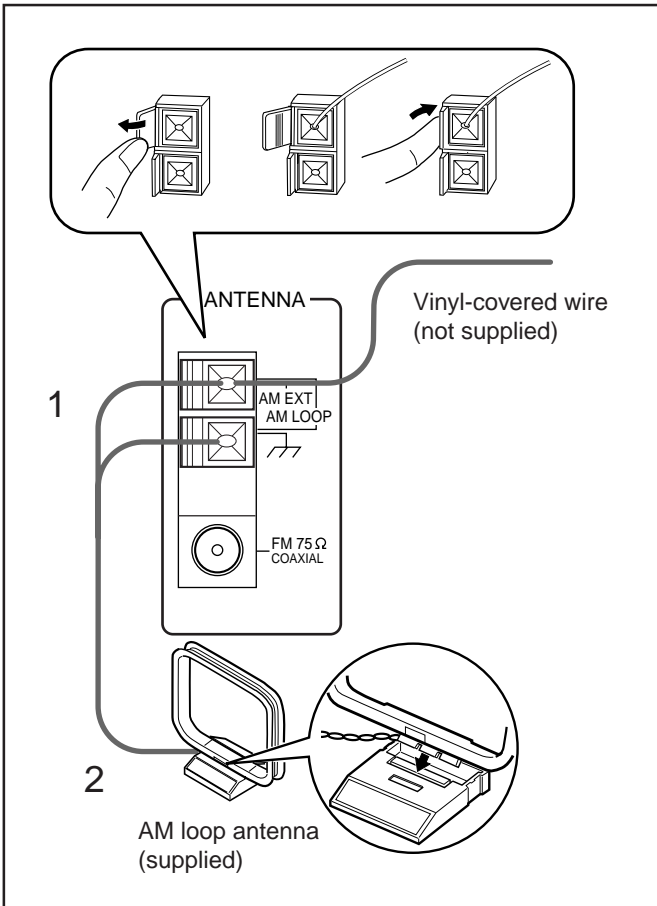

1 Connect the AM loop antenna to the AM LOOP terminals as illustrated.

- If the AM loop antenna wire is covered with vinyl, remove the vinyl by twisting it as shown in the diagram.

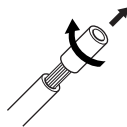

2 Turn the AM loop antenna until you have the best reception.

To connect an outdoor AM antenna

When reception is poor, connect a single vinyl-covered wire to the AM EXT terminal and extend it horizontally. The AM loop antenna must remain connected.



For better reception of both FM and AM

- Make sure the antenna conductors do not touch any other terminals and connecting cords.
- Keep the antennas away from metallic parts of the unit, connecting cords, and the AC power cord.

Connecting Speakers

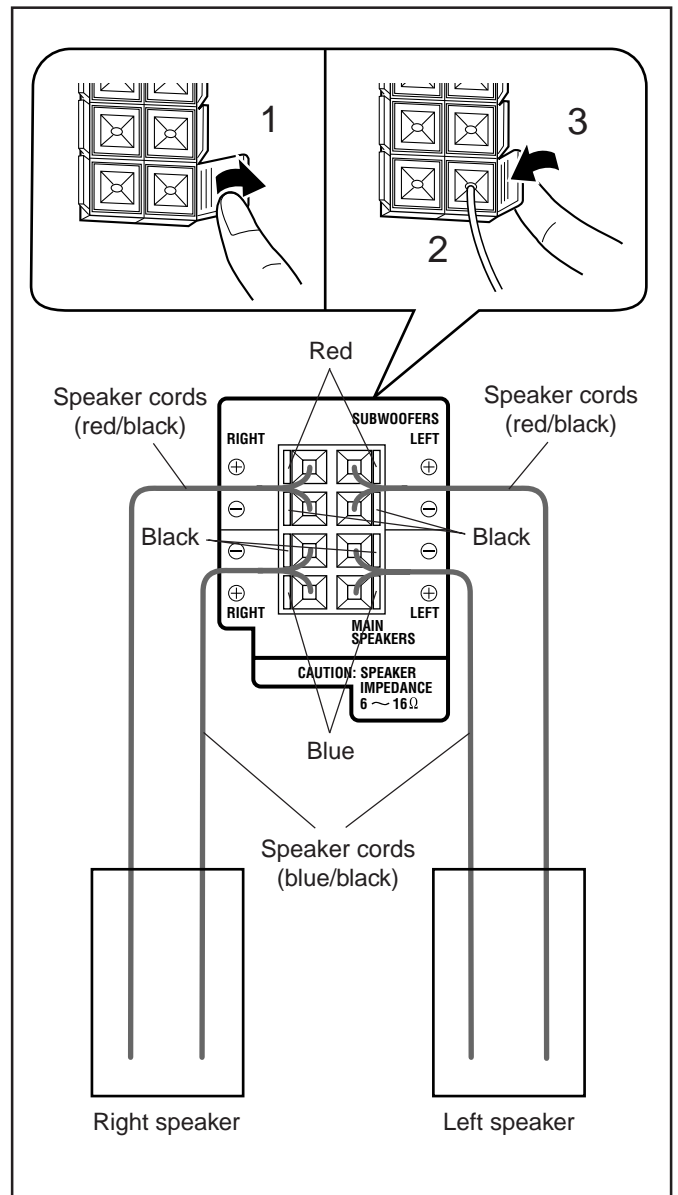

1 Open the speaker terminals on the rear of the unit.

2 Insert the end of the speaker cord into the terminal.

Match the polarity (colors) of the speaker terminals: Red (+) to red (+) and black (-) to black (-); Blue (+) to blue (+) and black (-) to black (-).

3 Close the speaker terminals.

IMPORTANT: Use only speakers with the same speaker impedance as indicated by the speaker terminals on the rear of the unit.



Connecting Other Equipment

You can connect both analog and digital equipment.



- DO NOT connect any equipment while the power is on.
- DO NOT plug in any equipment until all connections are complete.

To connect an analog component

Be sure that the plugs of the audio cords are colored: White plugs and jacks are for left audio signals, and red ones for right audio signals.

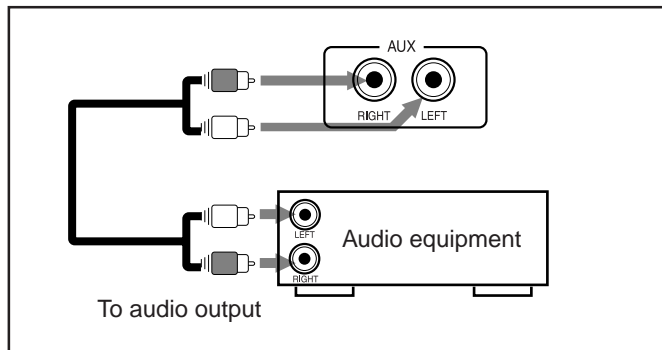

For playing the other equipment through this unit, connect between the audio output jacks on the other equipment and AUX jacks by using audio cords (not supplied).

To connect audio equipment with an optical digital input terminal

You can record CD sound onto the connected digital equipment.

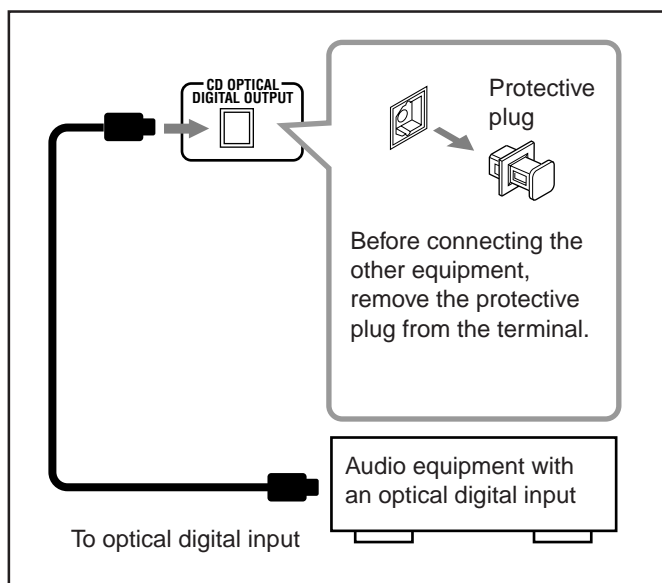

Connect an optical digital cord (not supplied) between the optical digital input terminal on the other equipment and the CD OPTICAL DIGITAL OUTPUT terminal.

Now, you can plug the AC power cord.

When connecting the AC power cord into a wall outlet, the unit automatically starts display demonstration.

IMPORTANT: Be sure to check all connections to be done before plugging the AC power cord into a wall outlet.

Canceling the Display Demonstration

On the unit ONLY:

To cancel the display demonstration, press CANCEL/DEMO until "DEMO OFF" appears on the display.

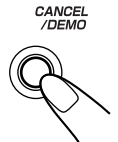

When you press other buttons

The display demonstration stops temporarily. It will start automatically again (if no operation is done for 2 minutes) unless you cancel it by pressing CANCEL/DEMO.

To start the display demonstration manually

Press and hold CANCEL/DEMO again for more than 1 second (while Ecology Mode is deactivated).

Common Operations

Turning On or Off the Power

To turn on the unit, press STANDBY/ON  so that the STANDBY lamp goes off.

WELCOME

To turn off the unit (on standby), press STANDBY/ON  again so that the STANDBY lamp lights up.

- The clock appears on the display (if Ecology Mode is not activated).

GOODBYE

- A little power is always consumed even while the unit is on standby.

To switch off the power supply completely, unplug the AC power cord from the AC outlet.



When you unplug the AC power cord or if a power failure occurs

The clock is reset to “0:00” right away, while the tuner preset stations (see page 12) will be erased in a few days.

Saving the Power Consumption While on Standby — Ecology Mode

You can save the power consumption only while the unit is turned off (on standby).

To activate the Ecology Mode, press ECO. “ECO” appears and the display illumination (including the display demonstration) disappears from the display.



- Each time you press the button, “ECO” and “NORMAL” appear alternately on the display.

To deactivate the Ecology Mode, press ECO again. “NORMAL” appears and the display illumination appears on the display.



About Ecology Mode

- You can also activate and deactivate Ecology Mode while the unit is on, but it takes effect only when the unit is on standby.
- While Ecology Mode is activated, the display demonstration is canceled temporarily.

Setting the Clock

Before operating the unit any further, first set the clock built in this unit. You can set the clock whether the unit is on or off.

On the unit ONLY:

1 Press CLOCK/TIMER.

The hour digits start flashing on the display.

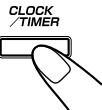

2 Turn / to adjust the hour, then press SET/DISPLAY.

The minute digits start flashing on the display.



- If you want to correct the hour after pressing SET/DISPLAY, press CANCEL/DEMO. The hour digits start flashing again.

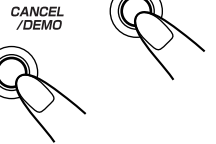
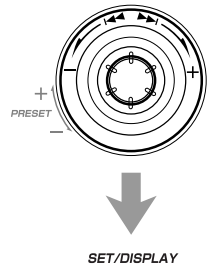

3 Turn / to adjust the minute, then press SET/DISPLAY.

CLOCK OK

To check the clock time

Press and hold SET/DISPLAY while playing any source.

- Each time you press and hold the button, the source indication and the clock time alternate on the display.

To adjust the clock again

If you have adjusted the clock before, you need to press CLOCK/TIMER repeatedly until the clock setting mode is selected.

- Each time you press the button, the clock/timer setting modes change as follows:

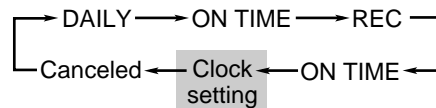

(The hour digits start flashing.)



When you unplug the AC power cord or if a power failure occurs

The clock loses the setting and is reset to “0:00.” You need to set the clock again.

Selecting the Sources





To listen to the FM/AM broadcasts, press FM/AM. (See page 12.)

To play back CDs, press CD . (See pages 13 – 16.)

To play back tapes, press TAPE  . (See page 17.)

To select the external equipment as the source, press AUX.



When you press the play button for a particular source (FM/AM, CD  , TAPE  , and AUX), the unit turns on (and the unit starts playing the source if it is ready — COMPU PLAY CONTROL).



About the audio level indicator

All the audio level indicators light up when no signals come in.

Adjusting the Volume

You can adjust the volume level only while the unit is turned on. The volume level can be adjusted in 32 steps (VOL MIN, VOL 01 — VOL 30, and VOL MAX).

Turn **VOLUME + / -** clockwise (+) to increase the volume or counterclockwise (-) to decrease it.

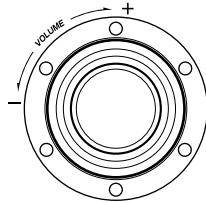
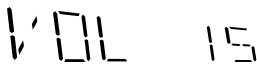

When using the remote control, press **VOLUME +** to increase the volume or press **VOLUME -** to decrease it.



For private listening

Connect a pair of headphones to the PHONES jack. No sound comes out of the speakers. Be sure to turn down the volume before connecting or putting on headphones.



DO NOT turn off (on standby) the unit with the volume set to an extremely high level; otherwise, a sudden blast of sound can damage your hearing, speakers and/or headphones when you turn on the unit or start playing any source next time. **REMEMBER** you cannot adjust the volume level while the unit is on standby.

To turn down the volume level temporarily

Press **FADE MUTING** on the remote control. The volume level gradually decreases to "VOL MIN."



To restore the sound, press the button again.

Reinforcing the Bass Sound

You can select one of the 4 subwoofer levels. This function only affects the playback sound, but does not affect your recording. The subwoofer level can be adjusted in 4 steps — LEVEL 1, LEVEL 2, LEVEL 3, and LEVEL 4 (MAX LEVEL).

Turn **SUBWOOFER LEVEL + / -** clockwise (+) to increase the subwoofer sound or counterclockwise (-) to decrease it.

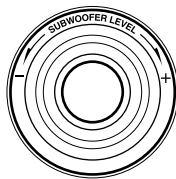

When using the remote control, press **SUBWOOFER LEVEL +** to increase the subwoofer volume or press **SUBWOOFER LEVEL -** to decrease it.

SUBWOOFER indicator always lights up when the unit is on.

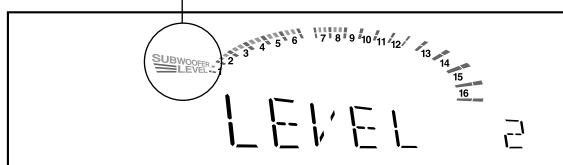

Selecting the Sound Modes

You can select one of the 6 preset sound modes (3 surround modes and 3 SEA — Sound Effect Amplifier — modes). This function only affects the playback sound, but does not affect your recording.

To select the sound modes, turn **SOUND MODE** (or press **SOUND MODE** on the remote control) until the sound mode you want appears on the display.

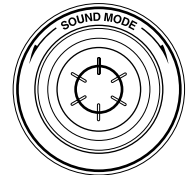

The **SOUND MODE** indicator also lights up on the display.

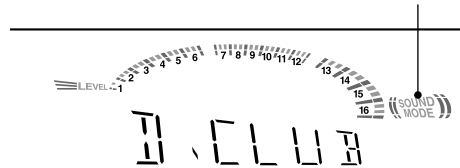

- The sound modes change as follows:

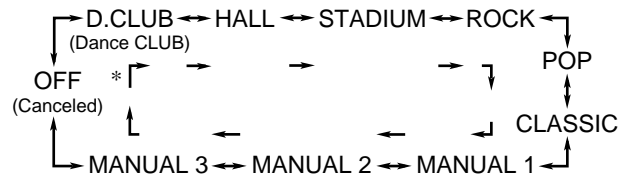

* When using the remote control, the sound mode changes in only one way.

Surround modes**:

- D. CLUB:** Increases resonance and bass.
- HALL:** Adds depth and brilliance to the sound.
- STADIUM:** Adds clarity and spreads the sound, like in an outdoor stadium.

SEA (Sound Effect Amplifier) modes:

- ROCK:** Boosts low and high frequency. Good for acoustic music.
- POP:** Good for vocal music.
- CLASSIC:** Good for classical music.

Manual modes:

- MANUAL 1/2/3:** Your individual mode stored in memory. See "Creating Your Own Sound Mode — Manual Mode" on page 11.
- OFF:** The sound mode is canceled. The **SOUND MODE** indicator goes off.

** Surround elements are added to the SEA elements to create a being-there feeling in your room.

When one of these modes is selected, the **SOUND MODE** indicator lights up as — 

While one of the SEA modes including manual modes (SEA elements without surround elements) is selected, the **SOUND MODE** indicator lights up as — 

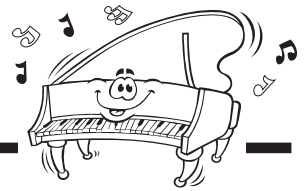

Creating Your Own Sound Mode — Manual Mode

You can change SEA pattern to suit your preference. These changed settings can be stored in the MANUAL 1, MANUAL 2, and MANUAL 3 modes.

- There is a time limit in doing the following steps. If the setting is canceled before you finish, start from step 1 again.

On the unit ONLY:

1 Select one of the preset sound modes.

- If you want to add the surround elements in your SEA pattern, select one of the surround modes (D.CLUB, HALL, or STADIUM) before starting the procedure below. (See “Selecting the Sound Modes” on page 10.)

2 Press and hold SET/DISPLAY until “SEA CONT” appears on the display.

SET/DISPLAY

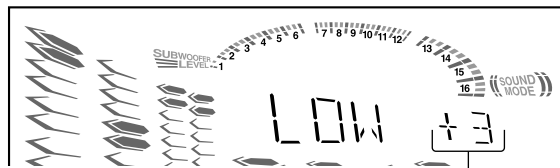

Current level appears.

3 Adjust the SEA pattern.

- 1) Turn ◀◀ / ▶▶ to select the frequency range to adjust (LOW, MID, HIGH).
- 2) Press ◀◀ or ▶▶ to adjust the level (-3 to +3) of the selected frequency range.
- 3) Repeat steps 1) and 2) to adjust the level of the other frequency ranges.

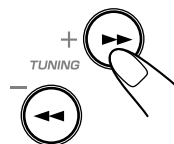
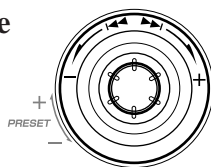

4 Press SET/DISPLAY again.

SET/DISPLAY

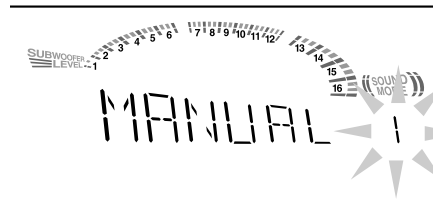

5 Turn ◀◀ / ▶▶ to select one of the MANUAL 1, MANUAL 2, and MANUAL 3 modes into which you want to store the SEA pattern.

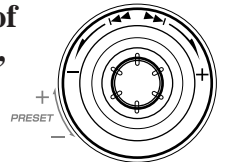

6 Press SET/DISPLAY again.

SET/DISPLAY

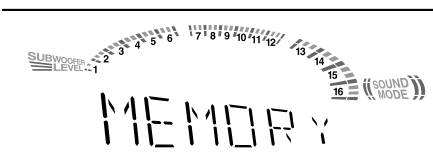

The SEA pattern you have created are stored into the MANUAL mode selected in the above step.

To use your own sound mode

Select MANUAL 1, MANUAL 2, or MANUAL 3 mode when using the sound modes. See “Selecting the Sound Modes” on page 10.



When you unplug the AC power cord or if a power failure occurs

The setting will be erased in a few days. If this happens, set the manual sound modes again.

Listening to FM and AM Broadcasts



Tuning in a Station

1 Press FM/AM.

The unit automatically turns on and tunes in the previously tuned station (either FM or AM).

- Each time you press the button, the band alternates between FM and AM.



2 Start searching for stations.

On the unit:

Press and hold TUNING + or TUNING – for more than 1 second.

On the remote control:

Press and hold ►► or ◄◄ for more than 1 second.

The unit starts searching for stations and stops when a station of sufficient signal strength is tuned in.

- If a program is broadcast in stereo, the ST (stereo) indicator lights up.

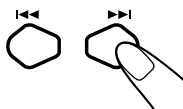
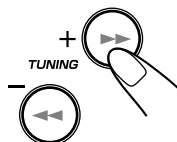

To stop searching, press TUNING + or TUNING – (or ►► / ◄◄ on the remote control).



When you press TUNING + or TUNING – (or ►► / ◄◄ on the remote control) briefly and repeatedly

The frequency changes step by step.

To change the FM reception mode

When an FM stereo broadcast is hard to receive or noisy, press FM MODE on the remote control so that the MONO indicator lights up on the display. Reception improves.



To restore the stereo effect, press FM MODE again so that the MONO indicator goes off. In this stereo mode, you can hear stereo sounds when a program is broadcasted.

Presetting Stations

You can preset 30 FM and 15 AM stations.

In some cases, test frequencies have been already memorized for the tuner since the factory examined the tuner preset function before shipment. This is not a malfunction. You can preset the stations you want into memory by following the presetting method.

- There is a time limit in doing the following steps. If the setting is canceled before you finish, start from step 1 again.

On the unit ONLY:

1 Tune in the station you want to preset.

- See “Tuning in a Station.”

2 Press SET/DISPLAY.



SET/DISPLAY



3 Turn PRESET + / – to select a preset number.

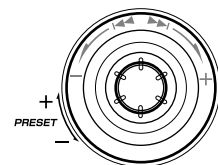

4 Press SET/DISPLAY again.



SET/DISPLAY



The tuned station in step 1 is stored in the preset number selected in step 3.

- Storing a new station on a used number erases the previously stored one.



When you unplug the AC power cord or if a power failure occurs

The preset stations will be erased in a few days. If this happens, preset the stations again.

Tuning in a Preset Station

1 Press FM/AM.

The unit automatically turns on and tunes in the previously tuned station (either FM or AM).

- Each time you press the button, the band alternates between FM and AM.



2 Select a preset number.

On the unit:

Turn PRESET + / –.

On the remote control:

Press the number buttons.

Ex.: For preset number 5, press 5.

For preset number 15, press +10, then 5.

For preset number 20, press +10, then 10.

For preset number 25, press +10, +10, then 5.

For preset number 30, press +10, +10, then 10.

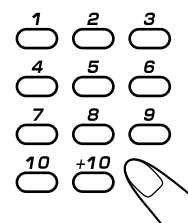
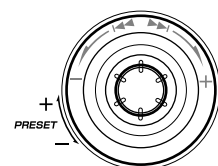

Playing Back CDs (CD/CD-R/CD-RW)

This unit has been designed to playback the following CDs:

- CD (Audio CD)
- CD-R (CD-Recordable)
- CD-RW (CD-ReWritable)

Continued use of irregular shape CDs (heart-shape, octagonal, etc.) can damage the System.

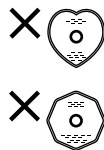

General Notes

In general, you will have the best performance by keeping your CDs and the mechanism clean.

- Store CDs in their cases, and keep them in cabinets or on shelves.
- Keep the system's disc trays closed when not in use.

When playing a CD-R or CD-RW

User-edited CD-Rs (CD-Recordable) and CD-RWs (CD-ReWritable) can be played back only if they are already "finalized."

- You can play back your original CD-Rs or CD-RWs recorded in music CD format. (However, they may not be played back depending on their characteristics or recording conditions.)
- Before playing back CD-Rs or CD-RWs, read their instructions or cautions carefully.
- Some CD-Rs or CD-RWs may not be played back on this unit because of their disc characteristics, damage or stain on them, or the player's lens is dirty.
- CD-RWs may require a longer readout time. This is caused by the fact that the reflectance of CD-RWs is lower than for regular CDs.

Loading CDs

On the unit ONLY:

1 Press **▲** for the disc tray (CD1, CD2, and CD3) you want to load a CD onto.

The unit automatically turns on and the disc tray comes out.

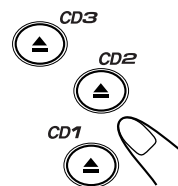

2 Place a disc correctly on the circle of the disc tray, with its label side up.

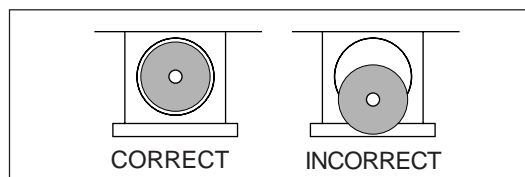

- When using a CD single (8 cm), place it on the inner circle of the disc tray.

3 Press the same **▲** you have pressed in step 1.

The disc tray closes, and the corresponding disc number lamp and disc indicator light up on the display (CD1, CD2, and CD3).

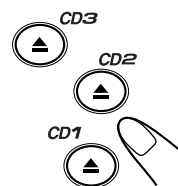

4 Repeat steps 1 to 3 to place other CDs.



When loading more than one CD continuously

When you press **▲** for the next tray you want to place another CD onto, the first disc tray automatically closes and then the next tray comes out.



About the disc indicators

Each disc indicator corresponds to the disc tray of the same number.

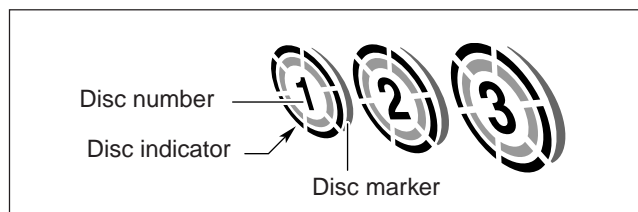

- The disc marker lights up for the disc number you have selected.
- The disc indicator flashes while the corresponding CD is being played.
- The disc indicators goes off when the unit has detected that there is no CD on the corresponding disc tray.

Playing Back the Entire Discs — Continuous Play

1 Load CDs.

2 Press one of the disc number buttons (CD1, CD2, and CD3) for the disc you want to play.

CD play starts from the first track of the selected disc and the disc number lamp starts flashing.

Tracks of the currently playing disc
(Track numbers exceeding 16 are not displayed.)

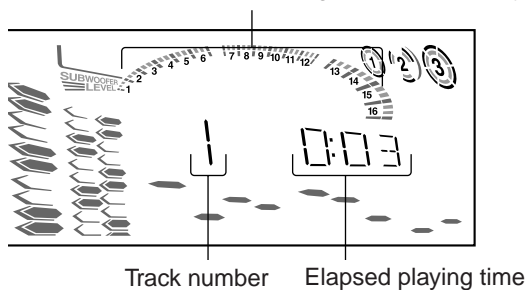

- Pressing CD ►/|| instead of the disc number buttons starts playing back if a CD is on the trays.
- If no CD is placed on the selected disc tray, "NO DISC" appears on the display.

To stop playing, press ■.

To remove the disc, press ▲ for the corresponding disc tray.



CD playback sequence

When 3 CDs* are loaded on the disc trays, they are played in one of the following sequences.

- When CD1 is pressed: CD1 ⇒ CD2 ⇒ CD3 (then stops)
- When CD2 is pressed: CD2 ⇒ CD3 ⇒ CD1 (then stops)
- When CD3 is pressed: CD3 ⇒ CD1 ⇒ CD2 (then stops)

* When only 2 CDs are loaded, they are played in the same order, but the disc tray without a CD is skipped.

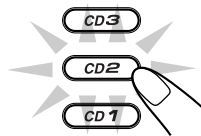

Basic CD Operations

While playing a CD, you can do the following operations.

To exchange CDs during playback of another

Press ▲ corresponding to a CD, not playing or selected currently, to eject and exchange the CD.

If you exchange CDs during play, the current play will not stop until all CDs you have exchanged are played.

To stop play for a moment

Press CD ►/||.

While pausing, the elapsed playing time flashes on the display.

To resume playing, press CD ►/||.



To go to another track

Turn ◀◀ / ▶▶ before or during playback (or press ◀◀ / ▶▶ on the remote control).

- ◀◀: Goes back to the beginning of the current or previous tracks.
- ▶▶: Skips to the beginning of the next or succeeding tracks.

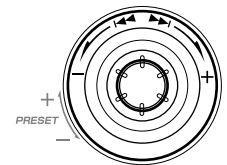

If you turn ◀◀ / ▶▶ (or press ◀◀ / ▶▶ on the remote control) before playing

You can change the tracks continuously.

To locate a particular point in a track

During play, press and hold ◀◀ or ▶▶ (or ◀◀ / ▶▶ on the remote control).

- ◀◀ (or ◀◀): Fast reverses the disc.
- ▶▶ (or ▶▶): Fast forwards the disc.

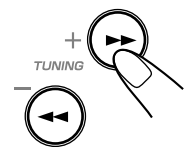

To go to another track directly using the number buttons

Pressing the number button(s) on the remote control before or during play allows you to start playing the track number you want.

Ex.: For track number 5, press 5.

For track number 15, press +10, then 5.

For track number 20, press +10, then 10.

For track number 32, press +10, +10, +10, then 2.

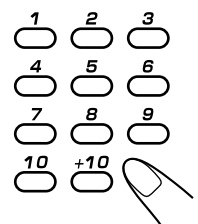

Programming the Playing Order of the Tracks — Program Play

You can arrange the order in which tracks play before you start playing. **You can program up to 32 tracks.**

- To use Repeat play (see page 16) for Program play, press REPEAT after starting Program play.
- There is a time limit in doing the following steps. If the setting is canceled before you finish, start from step 2 again.

1 Load CDs.

- If the current playing source is not the CD player, press CD ►/II, then ■ before going to the next step.

2 Press PROGRAM so that “PROGRAM” appears on the display.

The PRGM (program) indicator also lights up on the display.



- If a program has been stored in memory, the program is called up.

3 Press one of the disc number buttons (CD1, CD2, and CD3) to select the disc number you want to play.

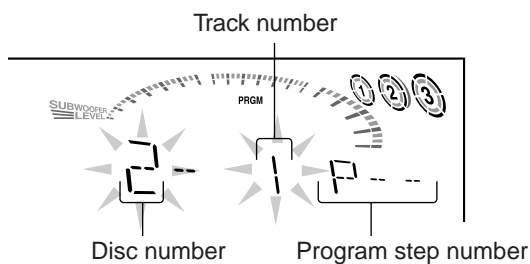

4 Select a track from the CD selected in the above step. On the unit:

Turn ◀◀ / ▶▶ to select the track number and press SET/DISPLAY.

On the remote control: Press the number buttons.

- For how to use the number buttons, see “To go to another track directly using the number buttons” on page 14.

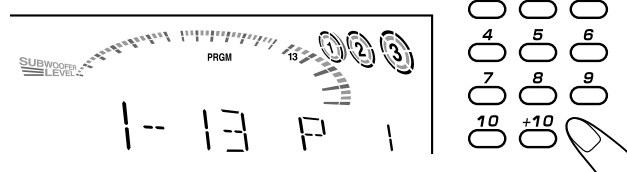

5 Program other tracks you want.

- To program tracks from the same disc, repeat step 4.
- To program tracks from a different disc, repeat steps 3 and 4.

6 Press CD ►/II.

The tracks are played in the order you have programmed.



To stop playing, press ■.

To exit from Program play mode, press PROGRAM again before or after play. The PRGM (program) indicator goes off. The program you have made is stored in memory.



- If you try to program a 33rd track “FULL” will appear on the display.
- If your entry is ignored You have tried to program a track from an empty tray, or a track number that does not exist on the CD (for example, selecting track 14 on a CD that only has 12 tracks). Such entries are ignored.
- If the total playing time is 100 minutes or more “-- : --” will appear on the display.

To check the program contents

Before playing, you can check the program contents by pressing ▶▶ or ◀◀ on the remote control.

- ▶▶ : Shows the programmed tracks in the programmed order.
- ◀◀ : Shows them in the reverse order.

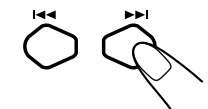

To modify the program

Before or after playing, you can erase the last programmed tracks by pressing CANCEL/DEMO.

- Each time you press the button, the programmed track shown on the display is erased from the program.
- Ejecting a CD will also erase the track numbers programmed from the ejected CD.



To add tracks in the program before playing, simply select the track numbers you want to add by following step 4 of the programming procedure.

To erase the entire program before or after playing, press ■. “PROGRAM” appears on the display.

- The program you have made will be erased, when you eject all the CDs.
- when you unplug the AC power cord.
- when a power failure occurs.



Playing at Random — Random Play

The tracks of all loaded CDs will play at random.

- To use Repeat play for Random play, press REPEAT after starting Random play.

1 Load CDs.

- If the current playing source is not the CD player, press CD ►/■, then ■ before going to the next step.

2 Press RANDOM so that “RANDOM” appears on the display.

The RANDOM indicator also lights up on the display.

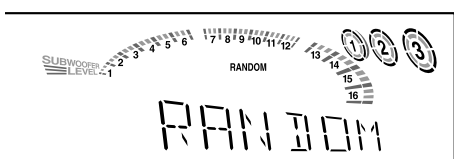

3 Press CD ►/■.

The tracks are played at random. Random play ends when all the tracks are played once.

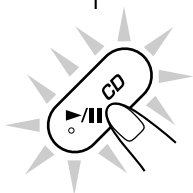

To skip the currently playing track, turn ◀◀ / ▶▶ to the right (or press ▶▶ on the remote control).



Even if you turn ◀◀ / ▶▶ to the left (or press ◀◀ on the remote control)

You cannot go back to the previous tracks during Random play.

To stop playing, press ■.

- Random play also stops when one of the disc trays is opened.

To exit from Random play mode, press RANDOM again before or after play.

Repeating Tracks or CDs — Repeat Play

You can have all the CDs, the program or the individual track currently playing repeat as many times as you like.

On the unit ONLY:

To repeat playing, press REPEAT during or before play. To use Repeat play for Program play and Random play, press the button after starting playback.

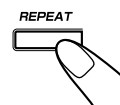

- Each time you press the button, Repeat play mode changes as follows, and the following indicator lights up on the display:

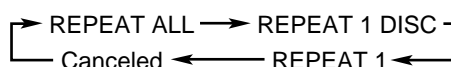

REPEAT ALL: Repeats all the tracks on all the CDs (continuously or at random), or all the tracks in the program.

REPEAT 1 DISC: Repeats all the tracks on one CD.
• REPEAT 1 DISC is not used for Program play and Random play.

REPEAT 1: Repeats one track on one CD.

To cancel Repeat play, press REPEAT repeatedly until the REPEAT indicators go off from the display.

- Repeat play is also canceled when you select Program play or Random play.

Prohibiting Disc Ejection — Tray Lock

You can prohibit CD ejection from the unit and lock CDs.

- This operation is possible only when the source is the CD player.

On the unit ONLY:

To prohibit disc ejection, press ▲ for any disc tray while holding down ■. (If there is any disc tray opened, close it first.)

“LOCKED” appears for a while, and the loaded CDs are locked.

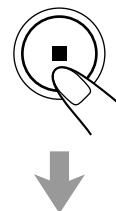

To cancel the prohibition and unlock the CDs, press ▲ for any disc tray while holding down ■.

“UNLOCKED” appears for a while, and the loaded CDs are unlocked.

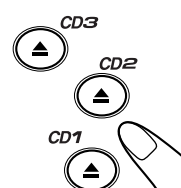

If you try to eject CDs

“LOCKED” appears to inform you that the Tray Lock is in use.

Playing Back Tapes



You can play back type I, type II, and type IV tapes without changing any settings.

Playing Back a Tape

1 Press EJECT (▲) for the deck you want to use.

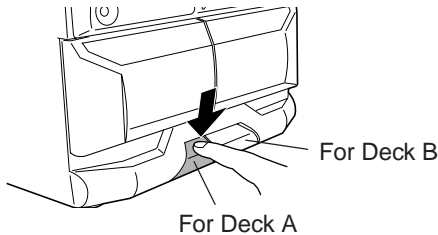

2 Put a cassette in with the exposed part of the tape down.

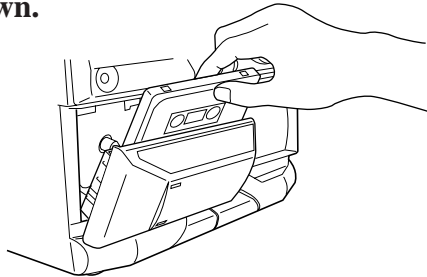

3 Close the cassette holder gently.

If you put cassettes in both decks A and B, the last deck you have put a cassette into is selected.

To select the other deck, press TAPE A/B.

4 Press TAPE ◀▶.

The tape play starts and the tape direction indicator (▶ or ◀) starts flashing slowly to indicate the tape running direction.

- Each time you press the button, the tape direction changes.
 - ▶ : plays the front side.
 - ◀ : plays the reverse side.
- If no cassette is inserted, “NO TAPE” appears on the display.

When the tape plays to the end, the deck automatically stops if the Reverse Mode is off. (See “To play both sides repeatedly — Reverse Mode.”)

To stop playing, press ■.

To operate the other deck, press TAPE A/B, then TAPE ◀▶.

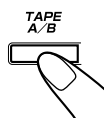

To fast-wind to the left or to the right, press ◀◀ or ▶▶ (◀◀◀ or ▶▶▶ on the remote control) while the tape is not running. The tape direction indicator (▶ or ◀) starts flashing quickly on the display.

To remove the cassette, press ▲ EJECT for deck A or EJECT ▲ for deck B.

To play both sides repeatedly — Reverse Mode

Reverse Mode works for both decks at the same time.

When it is in use, the tape automatically reverses at the end of a side and the unit starts playing for the other side of the tape, and repeats the same process.

To use Reverse Mode, press REVERSE MODE so that the Reverse Mode indicator on the display lights up like — (↔).



To cancel Reverse Mode, press the button again so that the Reverse Mode indicator on the display lights up like — ↔.



notes When Reverse Mode is on with cassettes in both decks A and B

After the reverse (◀) side of the tape finishes playing, the tape in the other deck starts playing.

Locating the Beginning of a Song — Music Scan

You can use Music Scan to locate the beginning of a song. Music Scan searches for blank portions that usually separate recorded songs, then plays the next song.

To find the beginning of the current song

During play, press ◀◀ or ▶▶ (◀◀◀ or ▶▶▶ on the remote control) in the **opposite direction** to the tape play.

The tape direction indicator of the opposite direction to the tape play starts flashing slowly.

Searching stops automatically at the beginning of the current song, and the current song starts automatically.

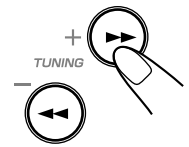

To find the beginning of the next song

During play, press ◀◀ or ▶▶ (◀◀◀ or ▶▶▶ on the remote control) in the **same direction** as the tape play.

The tape direction indicator of the same direction as the tape play starts flashing slowly and quickly alternately.

Searching stops automatically at the beginning of the next song, and the next song starts automatically.

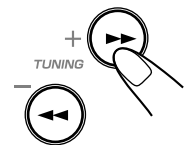

notes Music Scan works by detecting a 4-second long blank between each song, so it will not work well in the following cases

- No blank at the beginning of a song.
- Noise (often caused by much use or poor quality dubbing) which fills the blank.
- Long, very soft passages or pauses in a song.



The use of the C-120 or thinner tape is not recommended, since characteristic deterioration may occur and this tape easily jams in the pinch-rollers and the capstans.

IMPORTANT:

- It may be unlawful to record or play back copyrighted material without the consent of the copyright owner.
- The recording level is automatically set correctly, so it is not affected by the VOLUME, the SUBWOOFER LEVEL, and the SOUND MODE controls. Thus, during recording you can adjust the sound you are actually listening to without affecting the recording level.
- If recordings you have made have excessive noise or static, the unit may be too close to a TV. Increase the distance between the TV and the unit.
- You can use type I tape for recording.

To protect your recording

Cassettes have two small tabs on the back to protect from unexpected erasure or re-recording.

To protect your recording, remove these tabs.

To re-record on a protected tape, cover the holes with adhesive tape.

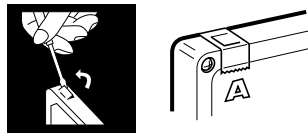

To keep the best recording and playback sound quality

If the heads, capstans, and pinch rollers of the cassette decks become dirty, the following will occur:

- Impaired sound quality
- Discontinuous sound
- Fading
- Incomplete erasure
- Difficulty in recording

To clean the heads, capstans, and pinch rollers

Use a cotton swab moistened with alcohol.

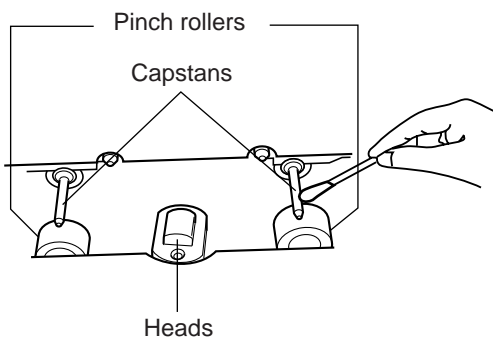

To demagnetize the heads

Turn off the unit, and use a head demagnetizer (available at electronics and audio shops).

Recording a Tape on Deck B

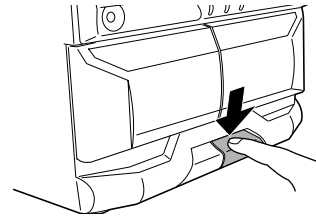

1 Press EJECT for the deck B.



2 Put a recordable cassette into deck B.

3 Close the cassette holder gently.

4 Check the tape direction of deck B.

- If the tape direction is not correct, press TAPE   twice then  to change the tape direction.

5 Start playing the source — FM, AM, CD player, deck A, or auxiliary equipment connected to AUX jacks.

- When the source is CD, you can also use CD Direct Recording (see page 19) and Auto Edit Recording (see page 20).
- When the source is deck A, you can also use the dubbing method. (See “Dubbing Tapes” on page 19.)

6 Start recording.

On the unit:

Press REC START/STOP.

On the remote control:

Press and hold REC START/STOP for more than 1 second.

The **REC** (recording) indicator lights up on the display and recording starts.

- If no cassette is inserted, “NO TAPE” appears on the display. If a protected tape is inserted, “NO REC” appears on the display.

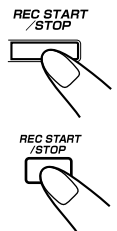

To stop recording immediately, press .

To remove the cassette, press EJECT  for deck B.

To record on both sides — Reverse Mode

Press REVERSE MODE so that the Reverse Mode indicator lights up like — (↔).



- When using the Reverse Mode for recording, start recording in the forward (▶) direction first. Otherwise, recording will stop when recording is done only on one side (reverse) of the tape.

To cancel Reverse Mode, press the button again so that the Reverse Mode indicator lights up like — ↔.

Dubbing Tapes

You can record from one tape to another.

On the unit ONLY:

- 1 Press TAPE ◀▶, then ■.

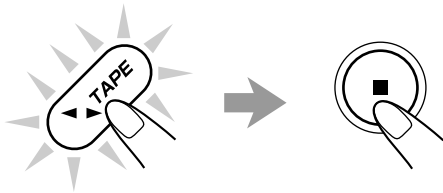

- 2 Put the source cassette in deck A, and a recordable cassette into deck B.

- Put the cassettes in both decks so that the tapes will run in the forward (▶) direction.

- 3 Press DUBBING.

The REC (recording) indicator lights up on the display and dubbing starts.



To stop dubbing, press ■ so that both decks (A and B) stop.

To record on both sides — Reverse Mode

Press REVERSE MODE so that the Reverse Mode indicator lights up like — (↔).



To cancel Reverse Mode, press the button again so that the Reverse Mode indicator lights up like — ↔.

CD Direct Recording

Everything on the CD goes onto the tape in the order it is on the CD, or according to the order you have made for Program play.

On the unit ONLY:

- 1 Put a recordable cassette into deck B.

- 2 Load CDs.

- 3 Press one of the disc number buttons (CD1, CD2, and CD3) to select the disc, then ■.

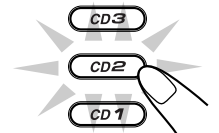

- If you want to make a program, perform steps 2 to 5 on page 15. After making a program, go to the next step.

- 4 Press CD REC START.

“CD REC” appears, and the REC (recording) indicator lights up on the display.



Deck B starts recording and the CD player starts playing. When the recording is done, “CD REC FINISHED” appears on the display, and the CD player and deck B stop.

To stop recording, press REC START/STOP or ■. So that a 4-second blank portion is created on the recording tape. (Remember a 4-second blank is important when using Music Scan — see page 17.)



To record on both sides — Reverse Mode

Press REVERSE MODE so that the Reverse Mode indicator lights up like — (↔).

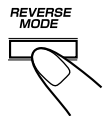

- When using the Reverse Mode for CD Direct Recording, start recording in the forward (▶) direction first. When the tape reaches its end while recording a song in the forward direction (▶), the last song will be re-recorded at the beginning of the reverse side (◀). If you start recording on the reverse side (◀), recording will stop when recording is done only on one side (reverse) of the tape.

To cancel Reverse Mode, press the button again so that the Reverse Mode indicator lights up like — ↔.



Auto Edit Recording

By using Auto Edit Recording, you can record the CD tracks to fit the tape. Auto Edit Recording makes a program by selecting the CD tracks in numerical order. However, to prevent the end of the last track on the front side from being cut off, the last track is selected so as to fit on the remaining tape length.

On the unit ONLY:

1 Load CDs.

- If the current playing source is not the CD player, press CD ►/II, then ■ before going to the next step.

2 Press EDIT.

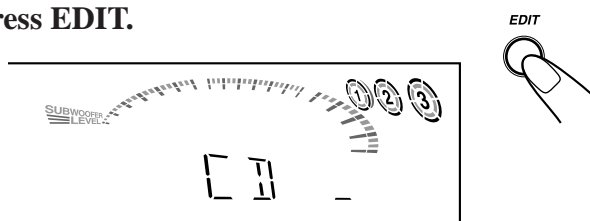

3 Press the disc number button (CD1, CD2, and CD3) for the disc you want to record from.

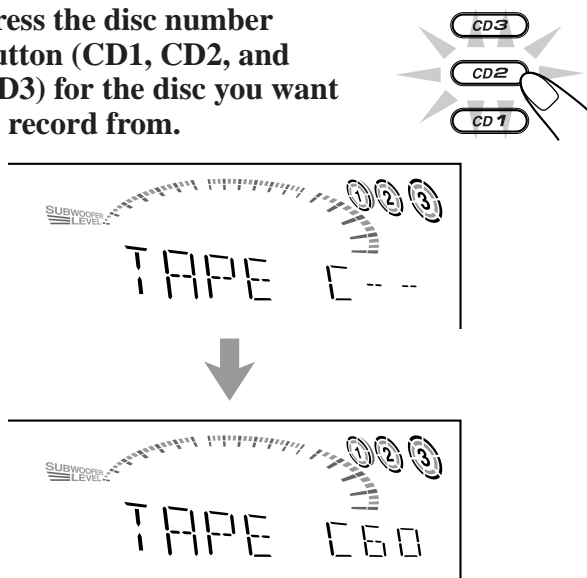

The optimum tape length for the disc appears.

To change the tape length manually

If the tape length selected is not satisfactory, you can change the tape length by turning I◀◀ / ▶▶I on the unit. You can select the tape length among the following — 40, 46, 50, 54, 60, 64, 70, 74, 80, 84, and 90.

4 Press SET/DISPLAY.

- Each time you press the button, the tracks to be recorded on the front side (“SIDE-A”) and on the reverse side (“SIDE-B”) alternate.

SET/DISPLAY



Tracks to be recorded on the reverse side (SIDE-B) appear.

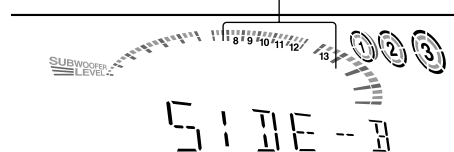

5 Put a recordable cassette of appropriate length into deck B.

6 Press REVERSE MODE so that the Reverse Mode indicator lights up like (↔).

- Without turning on the Reverse Mode (↔), recording will stop when the front side of the tape is recorded.

REVERSE MODE

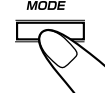

7 Press CD REC START.

“TAPE SIDE-A STAND-BY” appears, and the REC (recording) indicator lights up on the display.

CD REC START



Deck B starts recording then, about 10 seconds later, the CD player starts playing.

When the recording is done, “CD REC FINISHED” appears on the display, and the CD player and deck B stop.

- If a tape has not been rewound, deck B will rewind the tape before it starts recording.
- A 10-second blank portion is automatically created at the beginning of each side of the tape.

To stop during Auto Edit Recording

Press REC START/STOP or ■. So that a 4-second blank portion is created on the recording tape. (Remember a 4-second blank is important when using Music Scan — see page 17.)

To cancel Auto Edit Recording

Press CANCEL/DEMO or ■ before or after play.

Using the Timers

There are three timers available — Daily Timer, Recording Timer and Sleep Timer.

Before using the timers, you need to set the clock built in the unit. (See page 9.)

Using Daily Timer

With Daily Timer, you can wake to your favorite music or radio program. You can set the timer whether the unit is on or off.

How Daily Timer actually works

The unit automatically turns on, set the volume level to the preset level, and starts playing the specified source when the on-time comes (the ☺ indicator flashes just before the on-time, and continues flashing while the timer is operating). Then, when the off-time comes (“OFF” flashes just before the off-time), the unit automatically turns off (on standby).

The Daily timer works everyday automatically. If you do not want to use the Daily timer, turn off the Daily timer. (See “To turn on or off Daily Timer after its setting is done” on page 22.) The timer setting remains in memory until you change it.

- There is a time limit in doing the following steps. If the setting is canceled before you finish, start from step 1 again.
- To correct a mis-entry while setting the timer, press CANCEL/DEMO.

Before you start...

- *When using a CD as the source to play —*
 - Make sure there is a CD on the selected disc number tray.
- *When using a tape as the source to play —*
 - Make sure that a tape is in the deck whose deck indicator (A or B) is lit on the display.
 - Make sure that the tape direction is correct.
- *When using the external component as the source to play —*
 - Set the timer equipped on the external component at the same time.

On the unit ONLY:

- 1 Press **CLOCK/TIMER** repeatedly until “DAILY” appears on the display.



☺ indicator lights up and DAILY (Daily Timer) indicator also starts flashing on the display.

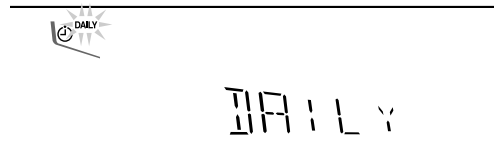

- Each time you press the button, the timer setting modes change as follows:

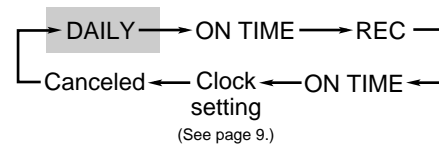

- 2 Press **CLOCK/TIMER** again.

“ON TIME” appears for 2 seconds, then the unit enters on-time setting mode.



- 3 Set the on-time you want the unit to turn on at.

- 1) Turn **◀◀ / ▶▶** to set the hour, then press **SET/DISPLAY**.
- 2) Turn **◀◀ / ▶▶** to set the minute, then press **SET/DISPLAY**. “OFF TIME” appears for 2 seconds on the display, then the unit enters off-time setting mode.

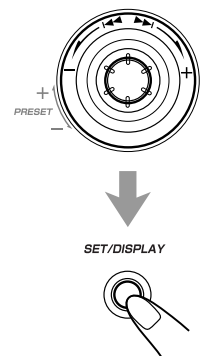

- 4 Set the off-time you want the unit to turn off (on standby) at.

- 1) Turn **◀◀ / ▶▶** to set the hour, then press **SET/DISPLAY**.
- 2) Turn **◀◀ / ▶▶** to set the minute, then press **SET/DISPLAY**. The unit enters source selecting mode.

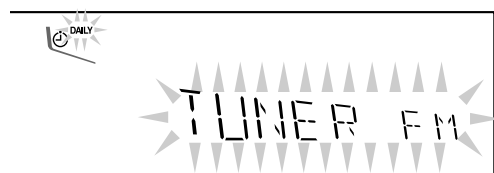

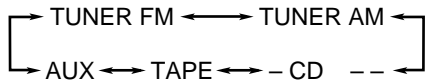

5 Turn   to select the source to play, then press SET/DISPLAY.

- The source changes as follows:







- TUNER FM: tunes into a specified preset FM station. → **Go to step 6.**
- TUNER AM: tunes into a specified preset AM station. → **Go to step 6.**
- CD --: plays a disc from a specified track of a specified disc. → **Go to step 6.**
- TAPE: plays a tape in deck A or B. → **Go to step 7.**
- AUX: plays an external source. → **Go to step 7.**

6 When selecting “TUNER FM” or “TUNER AM”

Turn   to select the preset station number, then press SET/DISPLAY.
The unit enters volume setting mode.

When selecting “- CD --”

- 1) Turn   to select the disc number, then press SET/DISPLAY.
- 2) Turn   to set the track number, then press SET/DISPLAY.
The unit enters volume setting mode.

7 Turn   to set the volume level.

- The volume level changes as follows:

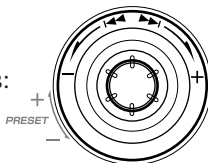
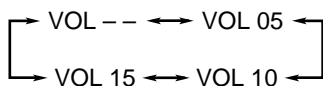

- If you select “VOL --,” the volume is set to the last level when the unit has been turned off.

8 Press SET/DISPLAY to complete the Daily Timer setting.

The DAILY (Daily Timer) indicator stops flashing and remains lit. The settings you have done are shown on the display in sequence.

SET/DISPLAY



9 Press STANDBY/ON  to turn off the unit (on standby) if you have set the Daily Timer with the unit turned on.

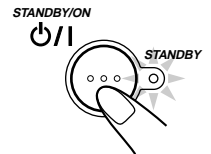

- **If the unit is turned on when the on-time comes**
Daily Timer does not work.
- **Even if you unplug the AC power cord or if a power failure occurs**
Once you set the timer, the timer setting may remain stored in memory in a few days. In this case, check whether the timer setting still remains or not.

To turn on or off Daily Timer after its setting is done

- 1 Press **CLOCK/TIMER** repeatedly until “DAILY” appears on the display.



- 2 To turn off the Daily Timer, press **CANCEL/DEMO**.



 indicator and the DAILY (Daily Timer) indicator go off from the display (“OFF” appears for a while).

The Daily Timer is canceled, but the setting for the Daily Timer remains in memory.

To turn on the Daily Timer, press SET/DISPLAY.

 indicator and the DAILY (Daily Timer) indicator light up on the display. The settings you have done are shown on the display in sequence for your confirmation.



Using Recording Timer

With Recording Timer, you can make a tape of a radio broadcast automatically. You can set the timer whether the system is on or off.

How Recording Timer actually works

The unit automatically turns on, tunes into the specified station, sets the volume level to “VOL MIN,” and starts recording when the on-time comes (the  indicator flashes just before the on-time, and continues flashing while the timer is operating). Then, when the off-time comes (“OFF” appears just before the off-time), the unit automatically turns off (on standby).

The timer setting remains in memory until you change it.

- There is a time limit in doing the following steps. If the setting is canceled before you finish, start from step 1 again.
- To correct a mis-entry while setting the timer, press CANCEL/DEMO.

On the unit ONLY:

1 Put a recordable cassette into deck B.

2 Press CLOCK/TIMER repeatedly until “REC” appears on the display.

The REC (Recording Timer) indicator also starts flashing on the display.

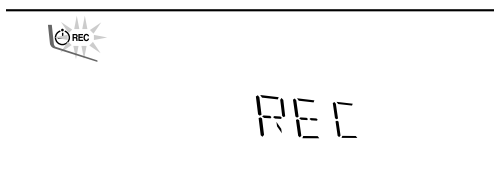

- Each time you press the button, the timer setting modes change as follows:

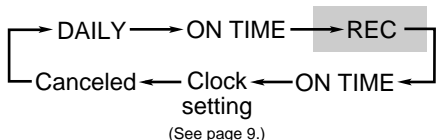





3 Press CLOCK/TIMER again.

“ON TIME” appears for 2 seconds, then the unit enters on-time setting mode.





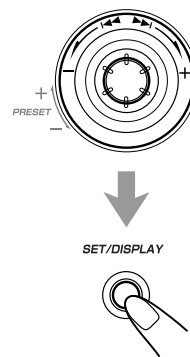

4 Set the on-time you want the unit to turn on at.





- 1) Turn  /  to set the hour, then press SET/DISPLAY.
- 2) Turn  /  to set the minute, then press SET/DISPLAY. “OFF TIME” appears for 2 seconds, then the unit enters off-time setting mode.



5 Set the off-time you want the unit to turn off (on standby) at.

- 1) Turn  /  to set the hour, then press SET/DISPLAY.
- 2) Turn  /  to set the minute, then press SET/DISPLAY. The unit enters preset station selecting mode.

6 Select the preset station.

- 1) Turn  /  to select the band (“TUNER FM” or “TUNER AM”), then press SET/DISPLAY.
- 2) Turn  /  to select a preset channel number, then press SET/DISPLAY. The REC (Recording Timer) indicator stops flashing and remains lit. The settings you have done are shown on the display in sequence.

7 Press STANDBY/ON to turn off the unit (on standby) if necessary.

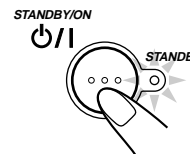

- **If you want to listen to another source while recording**
Press REC START/STOP or  to stop recording. Without stopping it, you cannot change the source.
- **Even if you unplug the AC power cord or if a power failure occurs**
Once you set the timer, the timer setting may remain stored in memory in a few days. In this case, check whether the timer setting still remains or not.



To turn on or off Recording Timer after its setting is done

1 Press **CLOCK/TIMER** repeatedly until “REC” appears on the display.



2 To turn off the Recording Timer, press **CANCEL/DEMO**.

The REC (Recording Timer) indicator goes off from the display.

The Recording Timer is canceled, but the setting for the Recording Timer remains in memory.



To turn on the Recording Timer, press **SET/DISPLAY**.

The REC (Recording Timer) indicator lights up on the display. The settings you have done are shown on the display in sequence for your confirmation.



Timer Priority

Since each timer can be set separately, you may wonder what happens if the setting for these timers overlaps. Here are examples.

Recording Timer has priority over Daily Timer and Sleep Timer.

- If Daily Timer is set to come on while Recording Timer is operating, Daily Timer will not come on at all.

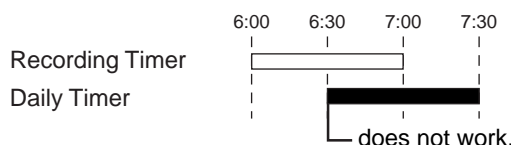

- If Recording Timer is set to come on while Sleep Timer is operating, Sleep Timer will not work (the SLEEP indicator does not go off).



Using Sleep Timer

With Sleep Timer, you can fall asleep to music. You can set Sleep Timer only while the unit is turned on.

How Sleep Timer actually works

The unit automatically turns off after the specified time length passes.

On the remote control ONLY:

1 Press **SLEEP**.

The time length until the shut-off time appears and the SLEEP indicator starts flashing on the display.



- Each time you press the button, the time length changes as follows:

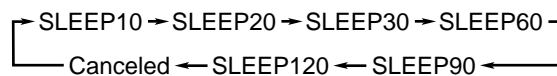

2 Wait for about 5 seconds after specifying the time length.

The SLEEP indicator stops flashing and remains lit.

To check the remaining time until the shut-off time, press SLEEP once so that the remaining time until the shut-off time appears for about 5 seconds.

To change the shut-off time, press SLEEP repeatedly until the desired time length appears on the display.

To cancel the setting, press SLEEP repeatedly so that the SLEEP indicator goes off.

- Sleep Timer is also canceled when you turn off the unit.

Maintenance



To get the best performance of the unit, keep your discs, tapes, and mechanism clean.

Handling discs



- Remove the disc from its case by holding it at the edge while pressing the center hole lightly.
- Do not touch the shiny surface of the disc, or bend the disc.
- Put the disc back in its case after use to prevent warping.

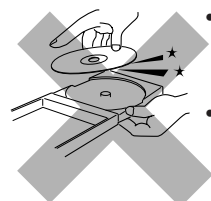

- Be careful not to scratch the surface of the disc when placing it back in its case.
- Avoid exposure to direct sunlight, temperature extremes, and moisture.



To clean the disc

Wipe the disc with a soft cloth in a straight line from center to edge.



DO NOT use any solvent — such as conventional record cleaner, spray, thinner, or benzine — to clean the disc.

Handling cassette tapes

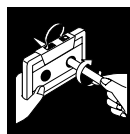

- If the tape is loose in its cassette, take up the slack by inserting a pencil in one of the reels and rotating.
- If the tape is loose, it may get stretched, cut, or caught in the cassette.



- Be careful not to touch the tape surface.



- Avoid the following places to store the tape:
 - In dusty places
 - In direct sunlight or heat
 - In moist areas
 - Near a magnet

Cleaning the unit

• Stains on the unit

Should be wiped off with a soft cloth. If the unit is heavily stained, wipe it with a cloth soaked in water diluted neutral detergent and wrung well, then wipe clean with a dry cloth.

• Since the unit may deteriorate in quality, become damaged or get its paint peeled off, be careful about the followings.

- DO NOT wipe it with a hard cloth.
- DO NOT wipe it strong.
- DO NOT wipe it with thinner or benzine.
- DO NOT apply any volatile substance such as insecticides to it.
- DO NOT allow any rubber or plastic to remain in contact with it for a long time.

Troubleshooting



If you are having a problem with your unit, check this list for a possible solution before calling for service. If you cannot solve the problem from the hints given here, or the unit has been physically damaged, call a qualified person, such as your dealer, for service.

Symptom	Cause	Action
Unable to cancel the display demonstration.	Other buttons will pressed to cancel the display demonstration.	Press CANCEL/DEMO on the unit. (See page 8.)
No sound is heard.	Connections are incorrect or loose.	Check all connections and make corrections. (See pages 6 to 8.)
Hard to listen to broadcasts because of noise.	<ul style="list-style-type: none"> Antennas are disconnected. The AM loop antenna is too close to the unit. The FM antenna is not properly extended and positioned. 	<ul style="list-style-type: none"> Reconnect the antennas correctly and securely. Change the position and direction of the AM loop antenna. Extend the FM antenna at the best position.
The disc sound is discontinuous.	The disc is scratched or dirty.	Clean or replace the disc. (See page 25.)
The disc tray does not open or close.	<ul style="list-style-type: none"> The AC power cord is not plugged in. Trays are locked. 	<ul style="list-style-type: none"> Plug the AC power cord. Unlock the trays. (See page 16.)
The disc does not play.	The disc is placed upside down.	Place the disc with the label side up.
The cassette holders cannot be opened.	Power supply from the AC power cord has been cut off while the tape was running.	Turn on the unit.
Impossible to record.	Small tabs on the back of the cassette are removed.	Cover the holes with adhesive tape.
Operations are disabled.	The built-in microprocessor may malfunction due to external electrical interference.	Unplug the AC power cord and then plug it back in.
Unable to operate the unit from the remote control.	<ul style="list-style-type: none"> The path between the remote control and the remote sensor on the unit is blocked. The batteries are exhausted. 	<ul style="list-style-type: none"> Remove the obstruction. Replace the batteries.

Specifications

CA-MXGT90

Amplifier section

Output Power
SUBWOOFERS: 88 W per channel, min. RMS, both channels driven into 6 Ω at 63 Hz with no more than 0.9% total harmonic distortion.
MAIN SPEAKERS: 28 W per channel, min. RMS, both channels driven into 6 Ω at 1 kHz with no more than 0.9% total harmonic distortion.

Audio input sensitivity/Impedance
(Measured at 1 kHz, with tape recording signal 300 mV)
AUX: 390 mV/50 k Ω

Digital output: CD OPTICAL DIGITAL OUTPUT
Signal wave length: 660 nm
Output level: -15 dBm to -12 dBm

Speakers/Impedance:
SUBWOOFERS: 6 Ω – 16 Ω
MAIN SPEAKERS: 6 Ω – 16 Ω

Tuner

FM tuning range: 87.50 MHz – 108.00 MHz
AM tuning range: 522 kHz – 1 629 kHz

CD player

CD capacity: 3 CDs
Dynamic range: 85 dB
Signal-to-noise ratio: 90 dB
Wow and flutter: Immeasurable

Cassette deck

Frequency response
Normal (type I): 50 Hz — 14 000 Hz
Wow and flutter: 0.15% (WRMS)

General

Power requirement: AC 240 V \sim , 50 Hz
Power consumption:
170 W (at operation)
24 W (on standby; with power saving off — Normal Mode)
1.1 W (on standby; with power saving on — Ecology Mode)
Dimensions (approx.): 265 mm x 335 mm x 401 mm (W/H/D)
(10⁷/₁₆ in. x 13¹/₄ in. x 15¹³/₁₆ in.)
Mass (approx.): 10.0 kg (22.1 lbs)

Supplied accessories

See page 6.

CA-MXGT80

Amplifier section

Output Power
SUBWOOFERS: 86 W per channel, min. RMS, both channels driven into 6 Ω at 63 Hz with no more than 0.9% total harmonic distortion.
MAIN SPEAKERS: 21 W per channel, min. RMS, both channels driven into 6 Ω at 1 kHz with no more than 0.9% total harmonic distortion.

Audio input sensitivity/Impedance
(Measured at 1 kHz, with tape recording signal 300 mV)
AUX: 390 mV/50 k Ω

Digital output: CD OPTICAL DIGITAL OUTPUT
Signal wave length: 660 nm
Output level: -15 dBm to -12 dBm

Speakers/Impedance:
SUBWOOFERS: 6 Ω – 16 Ω
MAIN SPEAKERS: 6 Ω – 16 Ω

Tuner

FM tuning range: 87.50 MHz – 108.00 MHz
AM tuning range: 522 kHz – 1 629 kHz

CD player

CD capacity: 3 CDs
Dynamic range: 85 dB
Signal-to-noise ratio: 90 dB
Wow and flutter: Immeasurable

Cassette deck

Frequency response
Normal (type I): 50 Hz — 14 000 Hz
Wow and flutter: 0.15% (WRMS)

General

Power requirement: AC 240 V \sim , 50 Hz
Power consumption:
160 W (at operation)
20 W (on standby; with power saving off — Normal Mode)
1.1 W (on standby; with power saving on — Ecology Mode)
Dimensions (approx.): 265 mm x 335 mm x 401 mm (W/H/D)
(10⁷/₁₆ in. x 13¹/₄ in. x 15¹³/₁₆ in.)
Mass (approx.): 10.0 kg (22.1 lbs)

Supplied accessories

See page 6.

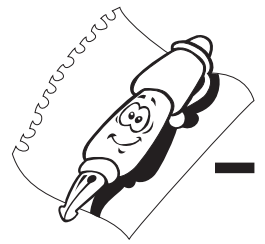

CA-MXG70

Amplifier section

Output Power

SUBWOOFERS: 80 W per channel, min. RMS, both channels driven into $6\ \Omega$ at 63 Hz with no more than 0.9% total harmonic distortion.

MAIN SPEAKERS: 21 W per channel, min. RMS, both channels driven into $6\ \Omega$ at 1 kHz with no more than 0.9% total harmonic distortion.

Audio input sensitivity/Impedance

(Measured at 1 kHz, with tape recording signal 300 mV)

AUX: 390 mV/50 k Ω

Digital output: CD OPTICAL DIGITAL OUTPUT

Signal wave length: 660 nm

Output level: -15 dBm to -12 dBm

Speakers/Impedance:

SUBWOOFERS: $6\ \Omega - 16\ \Omega$

MAIN SPEAKERS: $6\ \Omega - 16\ \Omega$

Design and specifications are subject to change without notice.

Tuner

FM tuning range: 87.50 MHz – 108.00 MHz

AM tuning range: 522 kHz – 1 629 kHz

CD player

CD capacity: 3 CDs

Dynamic range: 85 dB

Signal-to-noise ratio: 90 dB

Wow and flutter: Immeasurable

Cassette deck

Frequency response

Normal (type I): 50 Hz — 14 000 Hz

Wow and flutter: 0.15% (WRMS)

General

Power requirement: AC 240 V \sim , 50 Hz

Power consumption:

140 W (at operation)

20 W (on standby; with power saving off — Normal Mode)

1.1 W (on standby; with power saving on — Ecology Mode)

Dimensions (approx.): 265 mm x 335 mm x 401 mm (W/H/D)

(10⁷/₁₆ in. x 13¹/₄ in. x 15¹³/₁₆ in.)

Mass (approx.): 10.0 kg (22.1 lbs)

Supplied accessories

See page 6.



JVC INSTRUCTIONS

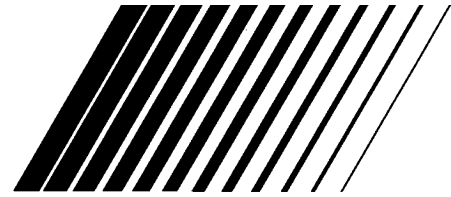

SPEAKER SYSTEM SP-MXG70

MANUAL DE INSTRUCCIONES: SISTEMA DE ALTAVOCES

INSTRUÇÕES: SISTEMA DE ALTIFALANTES

說明書：揚聲器系統

دليل التعليمات: لنظام السماعات

Thank you for purchasing JVC speakers.

Before you begin using them, please read the instructions carefully to be sure you get the best possible performance. If you have any questions, consult your JVC dealer.

Le estamos muy agradecidos por haber adquirido estos altavoces de JVC. Antes de utilizarlos, sírvase leer las instrucciones detenidamente a fin de obtener el mejor rendimiento posible. Si tienenaluna pregunta, acuda a su agente de JVC.

Gratos pela aquisição dos altifalantes JVC.

Antes de desfrutar este sistema, leia atentamente as instruções que o acompanham, de modo a assegurar-se da obtenção do melhor desempenho possível. Caso surjam dúvidas concernentes a este sistema, consulte o seu agente JVC.

感謝您惠購 JVC 揚聲器。

在開始使用之前，請您仔細閱讀本使用說明書，以確保您獲得揚聲器的最佳性能。如有疑問，請與 JVC 代理銷售商聯系。

نشكرك على شراء سماعات جي في سي JVC.

قبل أن تبدأ استعمالها، يرجى قراءة هذه التعليمات بعناية حتى تتأكد من حصولك على أفضل أداء. إذا كان عندك أية أسئلة، عندها راجع موزع JVC لديك.

— SAFETY INSTRUCTIONS —

“SOME DOS AND DON'TS ON THE SAFE USE OF EQUIPMENT”

This equipment has been designed and manufactured to meet international safety standards but, like any electrical equipment, care must be taken if you are to obtain the best results and safety is to be assured.

Do read the operating instructions before you attempt to use the equipment.

Do ensure that all electrical connections (including the mains plug, extension leads and interconnections between pieces of equipment) are properly made and in accordance with the manufacturer's instructions. Switch off and withdraw the mains plug when making or changing connections.

Do consult your dealer if you are ever in doubt about the installation, operation or safety of your equipment.

Do be careful with glass panels or doors on equipment.

DON'T continue to operate the equipment if you are in any doubt about it working normally, or if it is damaged in any way — switch off, withdraw the mains plug and consult your dealer.

DON'T remove any fixed cover as this may expose dangerous voltages.

DON'T leave equipment switched on when it is unattended unless it is specifically stated that it is designed for unattended operation or has a standby mode.

Switch off using the switch on the equipment and make sure that your family know how to do this.

Special arrangements may need to be made for infirm or handicapped people.

DON'T use equipment such as personal stereos or radios so that you are distracted from the requirements of traffic safety. It is illegal to watch television whilst driving.

DON'T listen to headphones at high volume as such use can permanently damage your hearing.

DON'T obstruct the ventilation of the equipment, for example with curtains or soft furnishing.

Overheating will cause damage and shorten the life of the equipment.

DON'T use makeshift stands and NEVER fix legs with wood screws — to ensure complete safety always fit the manufacturer's approved stand or legs with the fixings provided according to the instructions.

DON'T allow electrical equipment to be exposed to rain or moisture.

ABOVE ALL

- NEVER let anyone, especially children, push anything into holes, slots or any other opening in the case.
- this could result in a fatal electrical shock;
- NEVER guess or take chances with electrical equipment of any kind
- it is better to be safe than sorry!

Connection
Conexión
Ligaçao
接線
التوصيل

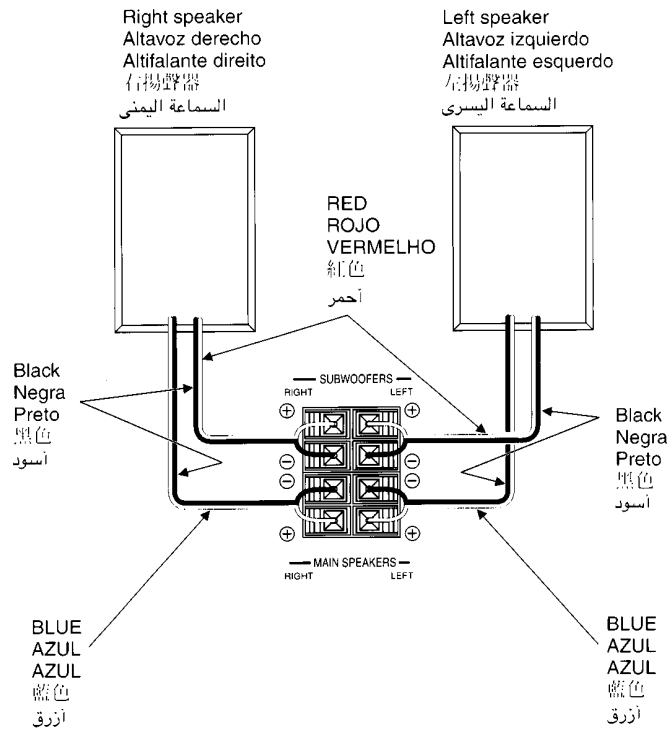

Amplifier output terminals
 Terminales de salida de amplificador
 Terminais de saída do amplificador
 放大器輸出端子
 نهايات خرج المضخم

CONNECTION

- DON'T use other amplifier to operate this speaker system except for CA-MXG70.
- Turn off power to the whole system before connecting the speakers to the amplifier.
- The maximum power handling capacity of the SP-MXG70 main speaker is 55 W/subwoofer is 110 W. Excessive input will result in abnormal noise and possible damage.

In cases where the signals described below are applied to the speakers, even if the signals are below the maximum allowable input, they may cause an overload and burn the wiring of the speakers. Be sure to lower the amplifier volume beforehand.

- 1) Noise during FM tuning.
- 2) High level signals containing high frequency components produced by a tape deck in the fast forward mode.
- 3) Click noise produced when turning power of other components on and off.
- 4) Click noise produced when connecting or disconnecting cords with the power on.
- 5) Click noise produced when the cartridge is replaced with the power on.
- 6) Click noise produced when operating amplifier switches.
- 7) Continuous high frequency oscillation or high pitch electronically produced musical instrument sound.
- 8) Howling when using a microphones.

SPECIFICATIONS

Type	: 3-way 3-speaker Bass-Reflex Type Twin Hyper Power-Drive Subwoofer
Speakers	
Subwoofer	: 14.0 cm (5-9/16 in.) cone × 1
Main woofer	: 16.0 cm (6-5/16 in.) cone × 1
Tweeter	: 5.0 cm (2 in.) cone × 1
Power Handling Capacity	
Subwoofer	: 110 W
Main Speaker	: 55 W
Impedance	
Subwoofer	: 6 Ω
Main Speaker	: 6 Ω
Frequency Range	
Subwoofer	: 29 Hz ~ 310 Hz
Main Speaker	: 70 Hz ~ 29 000 Hz
Sound Pressure Level	
Subwoofer	: 76 dB/W·m
Main Speaker	: 87 dB/W·m
Dimensions (W × H × D)	: 286 mm × 335 mm × 365 mm (11-5/16 in. × 13-1/4 in. × 14-3/8 in.)
Mass	: 6.3 kg (13.9 lbs) each

Design and specifications subject to change without notice.

CONEXIÓN

- NO utilice ningún otro amplificador para operar este sistema de altavoces excepto CA-MXG70.
- Desactive la alimentación de todo el sistema antes de conectar los altavoces al amplificador.
- La capacidad máxima de potencia del altavoz principal del SP-MXG70 es de 55 W y la del altavoz de subgraves es de 110 W. En casos donde las señales descritas más abajo se apliquen a los altavoces, aunque las mismas resulten menores que la entrada máxima permisible, pueden causar una sobrecarga y quemar el cableado de los altavoces. Asegúrese de disminuir el volumen del amplificador con anterioridad.
 - 1) Ruido durante la sintonía en FM.
 - 2) Señales de alto nivel que contengan componentes de alta frecuencia producidos por un magnetófono en el modo de avance rápido.
 - 3) Ruidos de conmutación provocados al encender y apagar otros componentes.
 - 4) Ruido de conmutación al conectar o desconectar cables con los componentes encendidos.
 - 5) Ruido de conmutación cuando se reemplaza la cápsula con los componentes encendidos.
 - 6) Ruido de conmutación provocados por la operación de los selectores del amplificador.
 - 7) Continua oscilación de alta frecuencia o de sonidos de tonos altos provocados por instrumentos electrónicos.
 - 8) Aullidos al utilizar micrófonos.

ESPECIFICACIONES

Tipo	: Reflex bajo con 3-altavoces y 3 vías Twin Hyper Power-Drive Subwoofer
Altavoces	
De subgraves	: Tipo cónico de 14,0 cm × 1
Principal	: Tipo cónico de 16,0 cm × 1
De agudos	: Tipo cónico de 5,0 cm × 1
Capacidad de potencia	
De subgraves	: 110 W
Principal	: 55 W
Impedancia	
De subgraves	: 6 Ω
Principal	: 6 Ω
Gama de frecuencias	
De subgraves	: 29 Hz–310 Hz
Principal	: 70 Hz–29 000 Hz
Nivel de presión acústica	
De subgraves	: 76 dB/W·m
Principal	: 87 dB/W·m
Dimensiones (An × Al × Prf)	: 286 mm × 335 mm × 365 mm
Peso	: 6,3 kg cada uno

El diseño y las especificaciones están sujetos a cambio sin previo aviso.

LIGAÇÃO

- NÃO use outro amplificador para operar este sistema de altifalantes à excepção do CA-MXG70.
- Desligue a alimentação de todo o sistema antes de iniciar as ligações dos altifalantes ao amplificador.
- A potência efectiva máxima do altifalante principal do SP-MXG70 é de 55 W; a do subwoofer é de 110 W. Uma entrada excessiva resultará em ruídos anormais e possíveis avarias. Nos casos em que os sinais descritos abaixo apresentem-se nos altifalantes, mesmo que os sinais estejam abaixo do nível de entrada permissível, poderão causar uma sobrecarga e o curto-circuito dos fios dos altifalantes. Certifique-se de reduzir o volume do amplificador de antemão.
 - 1) Interferências durante a sintonia de FM.
 - 2) Sinais com níveis elevados e com componentes de alta frequência produzidos pelo deck de cassetes durante o modo do avanço rápido.
 - 3) Estalidos produzidos quando do ligar/desligar da alimentação de outros componentes.
 - 4) Estalidos produzidos ao se ligar/desligar cabos de ligação com a alimentação ligada.
 - 5) Estalidos produzidos quando da troca da célula fonocaptadora com a alimentação ligada.
 - 6) Estalidos produzidos quando do activar/desactivar dos interruptores do amplificador.
 - 7) Oscilação contínua das altas frequências ou altas tonalidades electronicamente produzidas por sons de músicas instrumentais.
 - 8) Efeito de realimentação acústica (microfonia) quando da utilização de microfone.

ESPECIFICAÇÕES

Tipo	: Reflector de graves de 3 vías e 3 altifalantes Twin Hyper Power-Drive Subwoofer
Altifalantes	
Subwoofer	: Cónico de 14,0 cm × 1
Woofer principal	: Cónico de 16,0 cm × 1
Tweeter	: Cónico de 5,0 cm × 1
Potência efectiva	
Subwoofer	: 110 W
Altifalante principal	: 55 W
Impedância	
Subwoofer	: 6 Ω
Altifalante principal	: 6 Ω
Amplitude de frequência	
Subwoofer	: 29 Hz–310 Hz
Altifalante principal	: 70 Hz–29 000 Hz
Nível da pressão sonora	
Subwoofer	: 76 dB/W·m
Altifalante principal	: 87 dB/W·m
Dimensões (larg. × alt. × prof.)	: 286 mm × 335 mm × 365 mm
Peso	: 6,3 kg cada

Desenho e especificações sob reserva de alterações sem aviso prévio.

接線

- 請勿使用其他放大器操作 CA-MXG70 以外的揚聲器系統。
- 要將揚聲器連接到放大器時，須關掉全裝置系統的電源。
- SP-MXG70 主揚聲器的最大功率儲備容量為 55 W (瓦)，副低音喇叭的為 110 W (瓦)。過大的輸入，將造成異常噪聲，甚至損壞揚聲器。當下列信號輸入揚聲器時，即使該信號低於最大容許輸入，仍有可能造成過載而燒毀揚聲器導線，故請預先調低放大器的音量控制，以策安全。
 - 1) 在 FM 調諧中產生的噪聲。
 - 2) 磁帶錄音機的快進模式中產生的含有高頻成分的高電平信號。
 - 3) 開關其它組成部分電源時產生的卡嗒噪聲。
 - 4) 接通電源進行接線或斷線時產生的卡嗒噪聲。
 - 5) 接通電源更換卡盤時產生的卡嗒噪聲。
 - 6) 操作放大器開關時產生的卡嗒噪聲。
 - 7) 連續的高頻率振蕩或高音調電子裝置產生的樂器聲。
 - 8) 使用麥克風時發生的嘯聲。

التوصيل

- لا تستعمل مضخم صوت آخر لتشغيل نظام السماعات هذا باستثناء للموديل CA-MXG70.
- افضل الطاقة لكل النظام قبل توصيل السماعات بالمضخم.
- أقصى سعة للقدرة لتشغيل السماعة الرئيسية لنظام السماعات SP-MXG70 هي 55 واط وللمجهر الفرعي للترددات المنخفضة هي 110 واط. الدخول الزائد سيؤدي الى تشويش شاذ وامكانية حدوث تلف.
- في الحالات التي تنطبق فيها الاشارات الموصوفة أدناه على السماعات، حتى لو كانت الاشارات دون أقصى دخل مسموح به، فانها قد تسبب حملاً زائداً وحرق اسلاك السماعات. لهذا تأكد من تخفيض جهارة صوت المضخم مقدماً.
- 1) تشويش أثناء موافقة البث FM.
- 2) اشارات ذات مستوى مرتفع تحوي مركبات تردد عال ناتجة عن جهاز كاسيت في وضع التقديم السريع.
- 3) صوت طقطقة ينتج عند تشغيل وايقاف الطاقة على الاجهزة الاخرى.
- 4) صوت طقطقة ينتج عند وصل أو فصل الاسلاك بينما تكون الطاقة موصلة.
- 5) صوت طقطقة ينتج عند استقبال الكارتريج بينما تكون الطاقة موصلة.
- 6) صوت طقطقة ينتج عند تشغيل مفاتيح المضخم.
- 7) ذبذبة مستمرة ذات تردد مرتفع أو نغمة عالية ناتجة الكترونياً عن صوت آلة موسيقية.
- 8) زعيق عند استخدام ميكروفون.

規格

類型	: 3 通道 3 揚聲器低音反射型 Twin Hyper Power Drive Subwoofer
揚聲器	
副低音喇叭	: 錐形紙盆 14.0 cm × 1
主喇叭	: 錐形紙盆 16.0 cm × 1
高音喇叭	: 錐形紙盆 5.0 cm × 1
最大功率	
副低音喇叭	: 110 W (瓦)
主揚聲器	: 55 W (瓦)
阻抗	
副低音喇叭	: 6 Ω (歐姆)
主揚聲器	: 6 Ω (歐姆)
頻率範圍	
副低音喇叭	: 29 Hz — 310 Hz
主揚聲器	: 70 Hz — 29 000 Hz
聲壓級	
副低音喇叭	: 76 dB/W · m
主揚聲器	: 87 dB/W · m
尺寸 (W×H×D)	: 286 mm × 335 mm × 365 mm
質量	: 每個 6.3 kg

設計與規格如有變更，恕不另行通知。

المواصفات

النوع	: ثلاثي التكوين 3 سماعات من النوع العاكس Twin Hyper Power-Drive Subwoofer
السماعات	
المجهر الفرعي للترددات المنخفضة	: نوع مخروطي 14.0 سم × 1
المجهر الرئيسي للترددات المنخفضة	: نوع مخروطي 16.0 سم × 1
مجهر الترددات العالية	: نوع مخروطي 5.0 سم × 1
سعة تشغيل القدرة	
المجهر الفرعي للترددات المنخفضة	: 110 واط
السماعة الرئيسية	: 55 واط
المقاومة	
المجهر الفرعي	: 6 أوم
السماعة الرئيسية	: 6 أوم
مجال الترددات	
المجهر الفرعي	: 29 — 310 هرتز
السماعة الرئيسية	: 70 — 29000 هرتز
مستوى ضغط الصوت	
المجهر الفرعي	: 76 ديسيبل/واط-متر
السماعة الرئيسية	: 87 ديسيبل/واط-متر
الابعاد	: 286 مم × 335 مم × 365 مم
الوزن	: 6.3 كجم لكل وحدة

التصميم والمواصفات عرضة للتغيير دون إشعار.